

# Project 1

## Form design for a Jet-ski

by Samudra Shipyard Ltd.



- Abhishek Gogoi  
156390004  
Mobility & Vehicle Design

Samudra

IDC  
IIT Bombay

**Project Background**

# PWC ?



'stand up'

INR 14 lakhs (approx)

'sit down'



INR 20 lakhs+

## Back in Samudra Workshop



in-board PWC



out-board PWC  
by Samudra



# Benchmarking the Jet-ski



Kawasaki, Yamaha and Seadoo; among the popular Jet-ski brands



## Target Users ?



## Package ?



## Design Brief

Design the deck of a 2-seater PWC for Samudra Shipyard Ltd.



## Genre ?



# Technical aspects of a Jet-ski.

PWC - Personal Water Craft

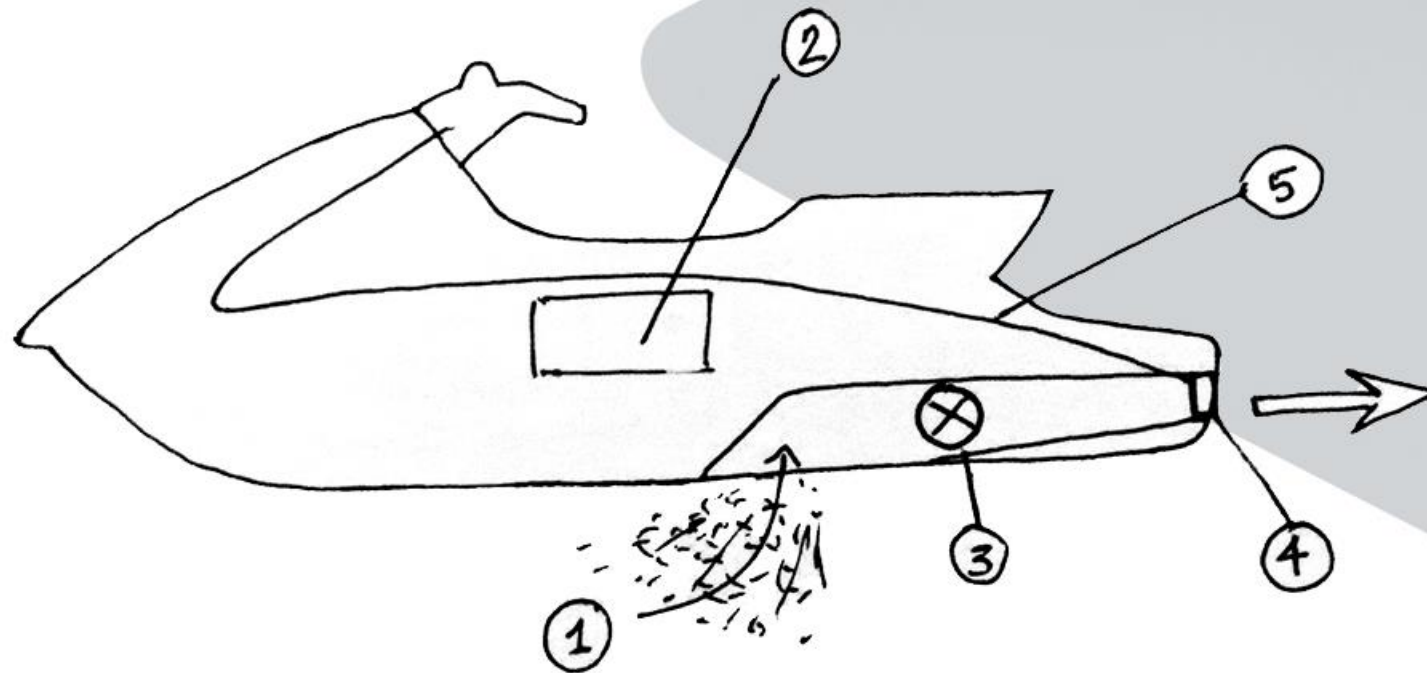

1. Intake grate

2. Engine

3. Impeller

4. Steerable jet propeller

5. Steering connection for swivelling

# Design Consideration

## Design Constraints

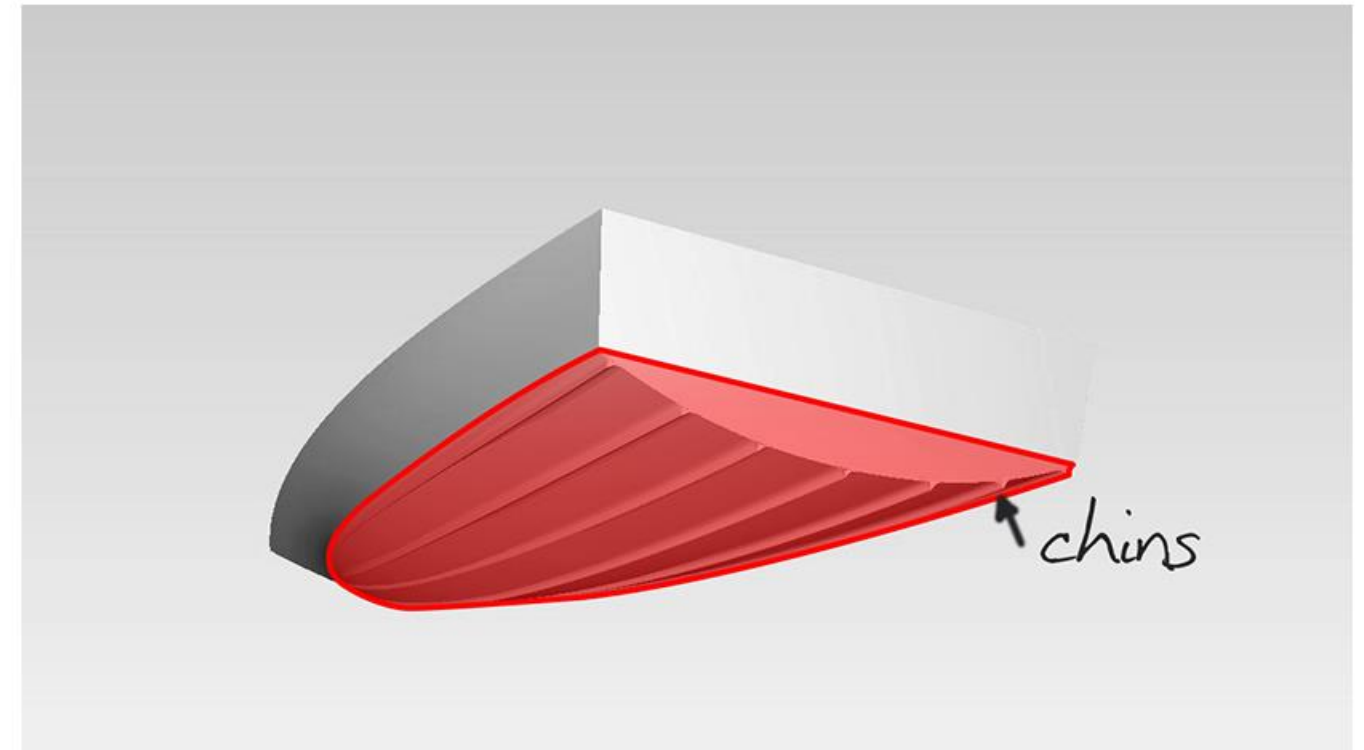
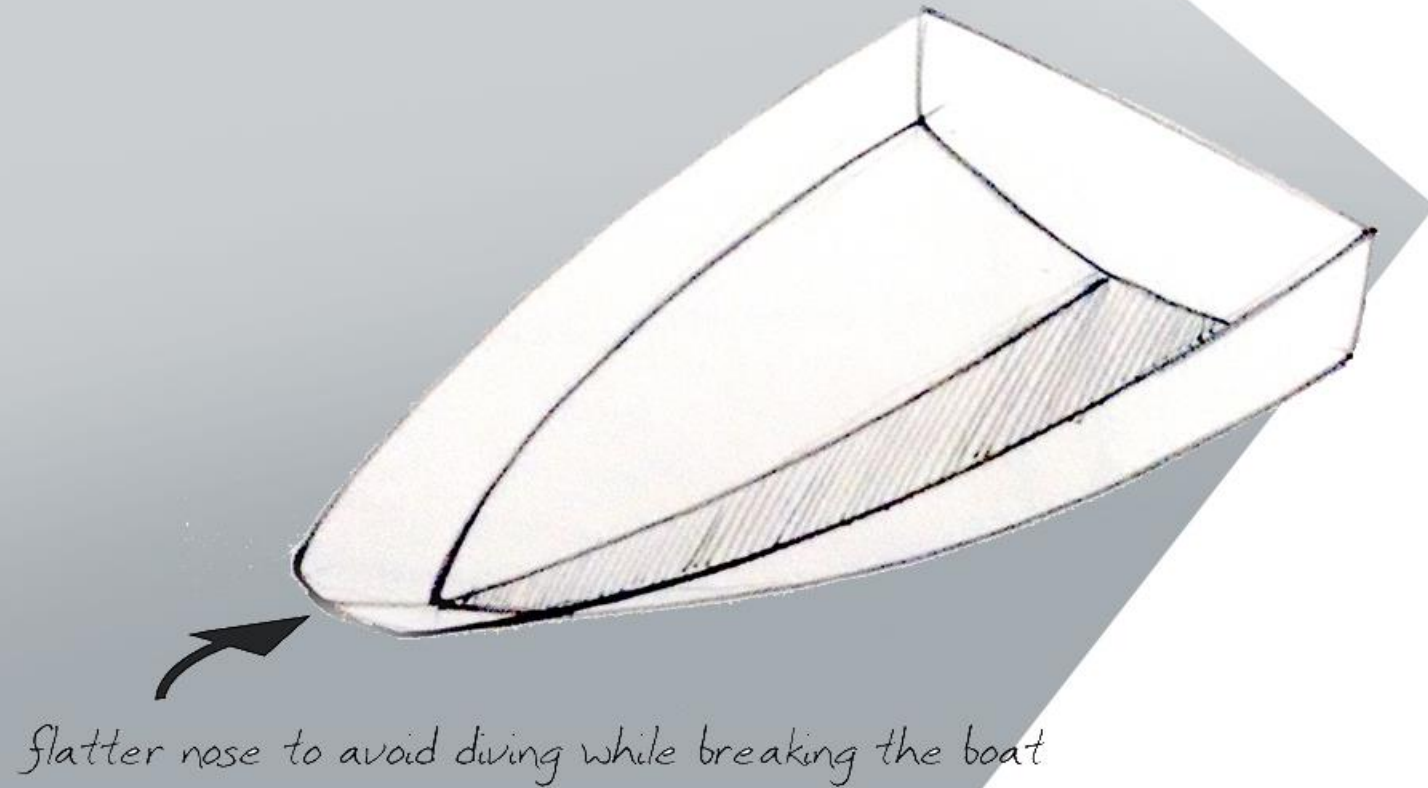

**Chins** in the hull are **vital** for its motion.

**Flatter nose** to avoid diving

# Design Consideration

## Technical Considerations

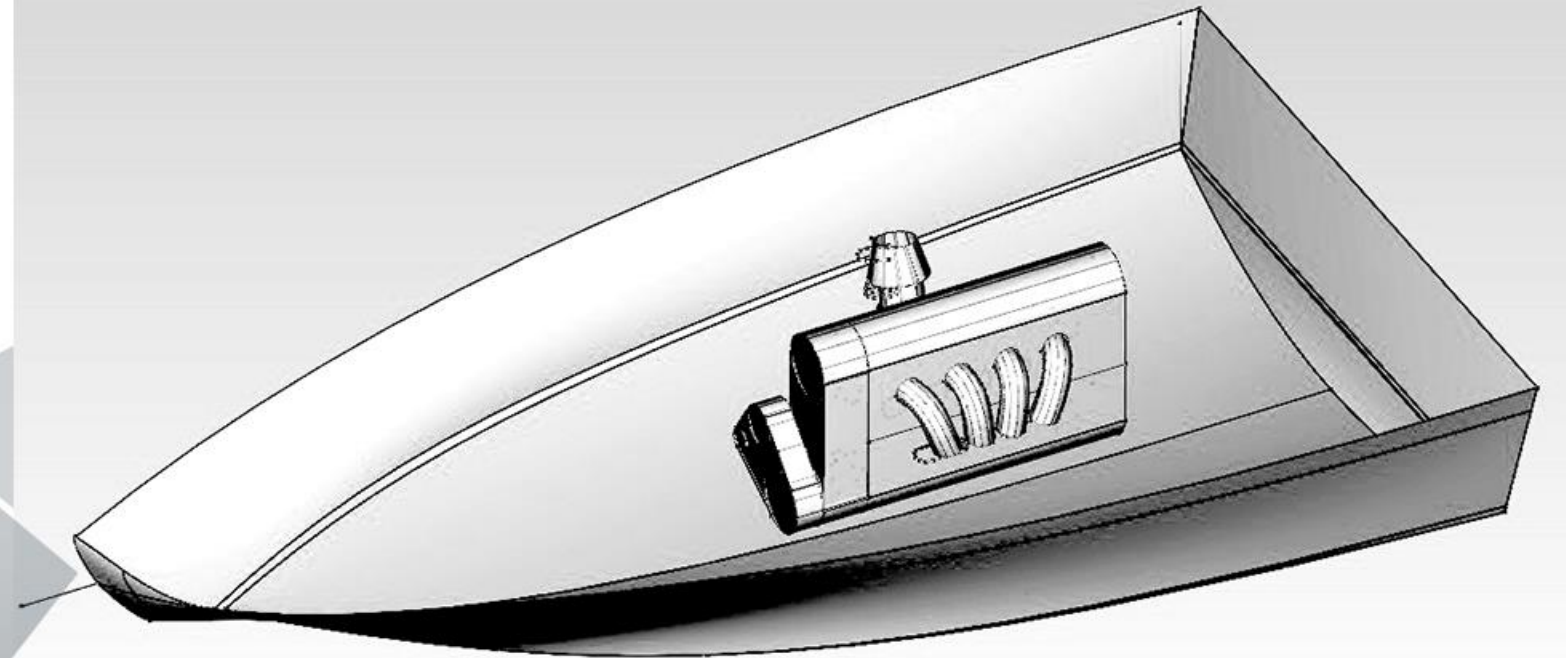

**Engine** must be at the **centre**

**Rear weighted**

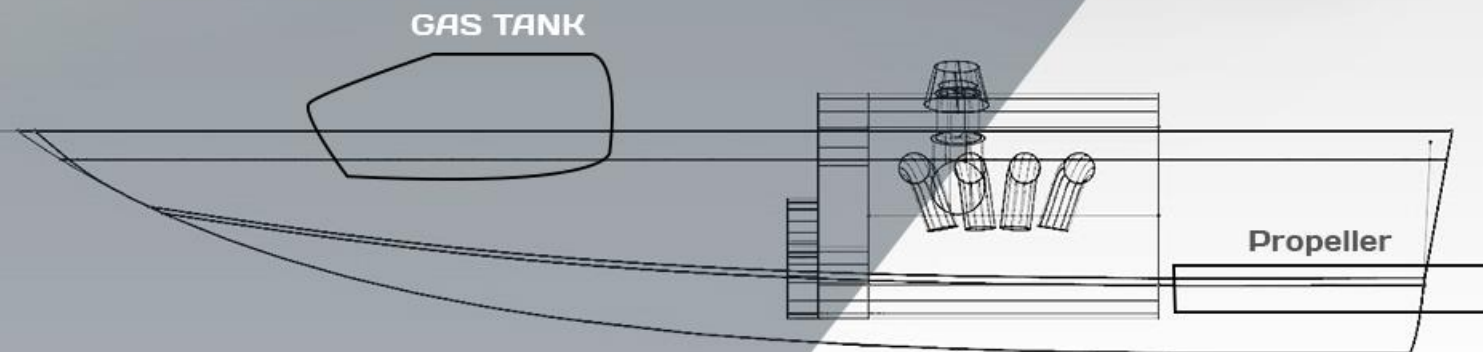

# Studying the existing hull



# Studying the existing hull

Top half of the hull could be altered, making it possible for a flatter nose

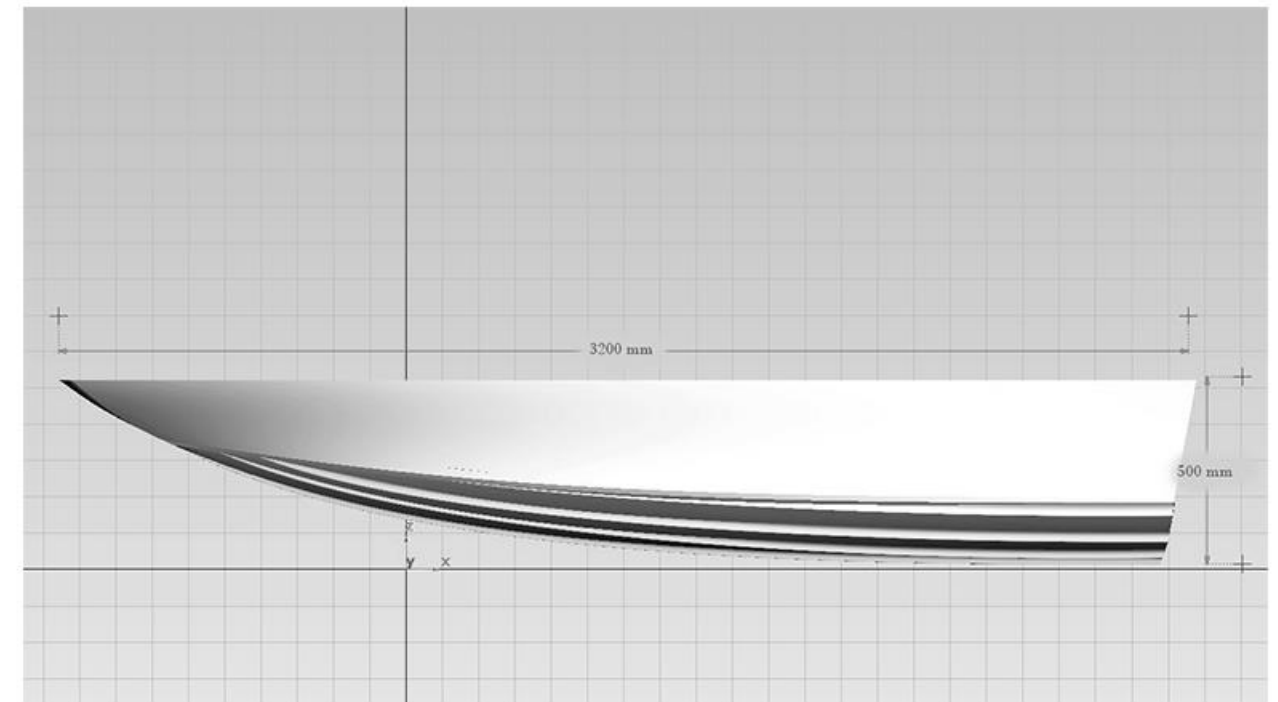
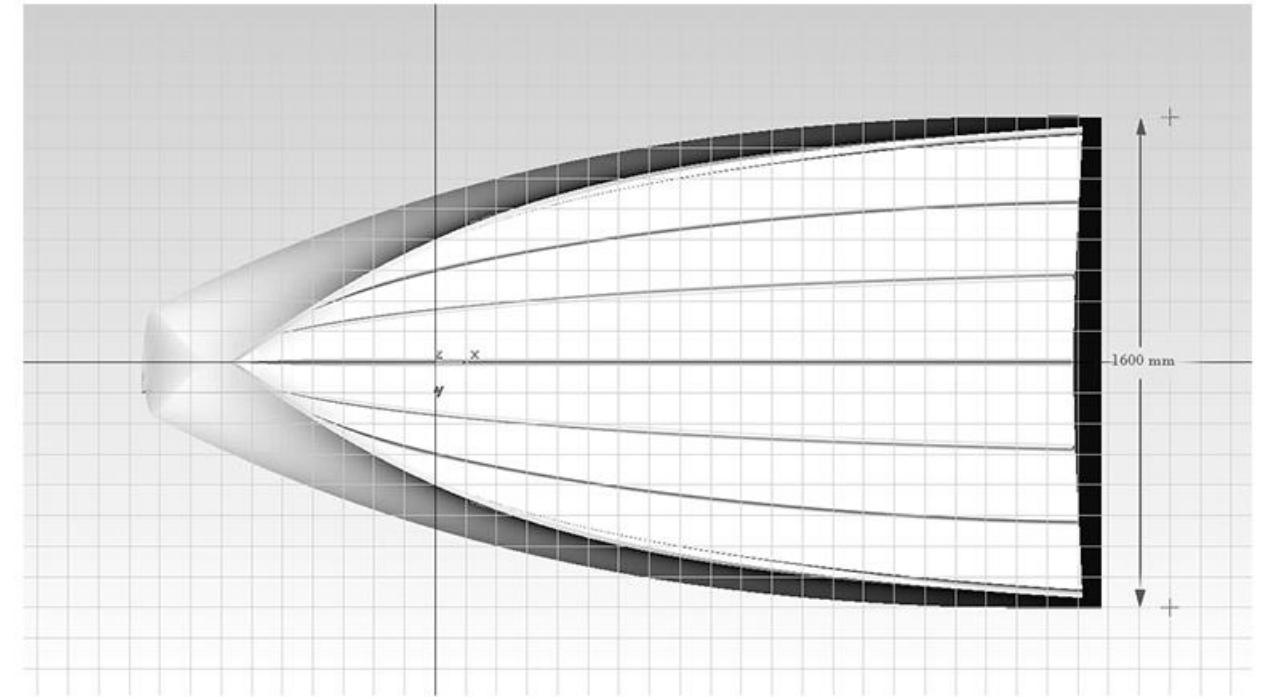
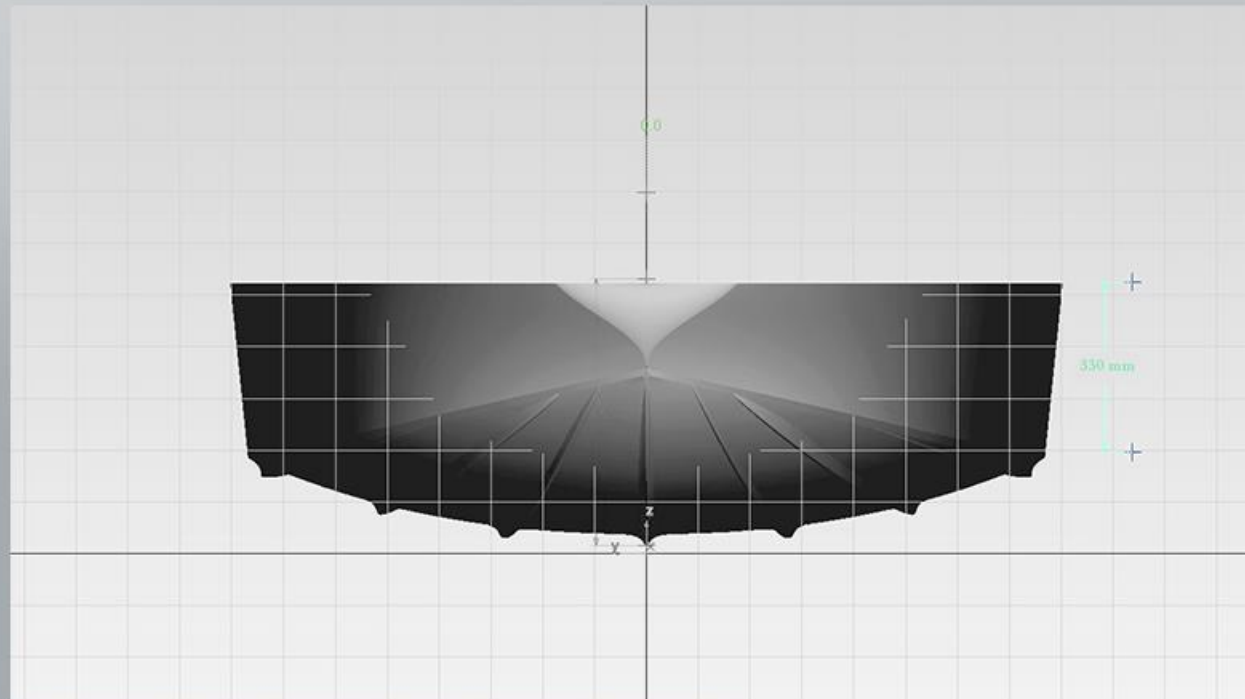

# Studying the engine



**1296 cc esteem engine**

**Carburetor instead of MPFi**

**Possibility of compact air-filter**

# Riding posture and pillion stance

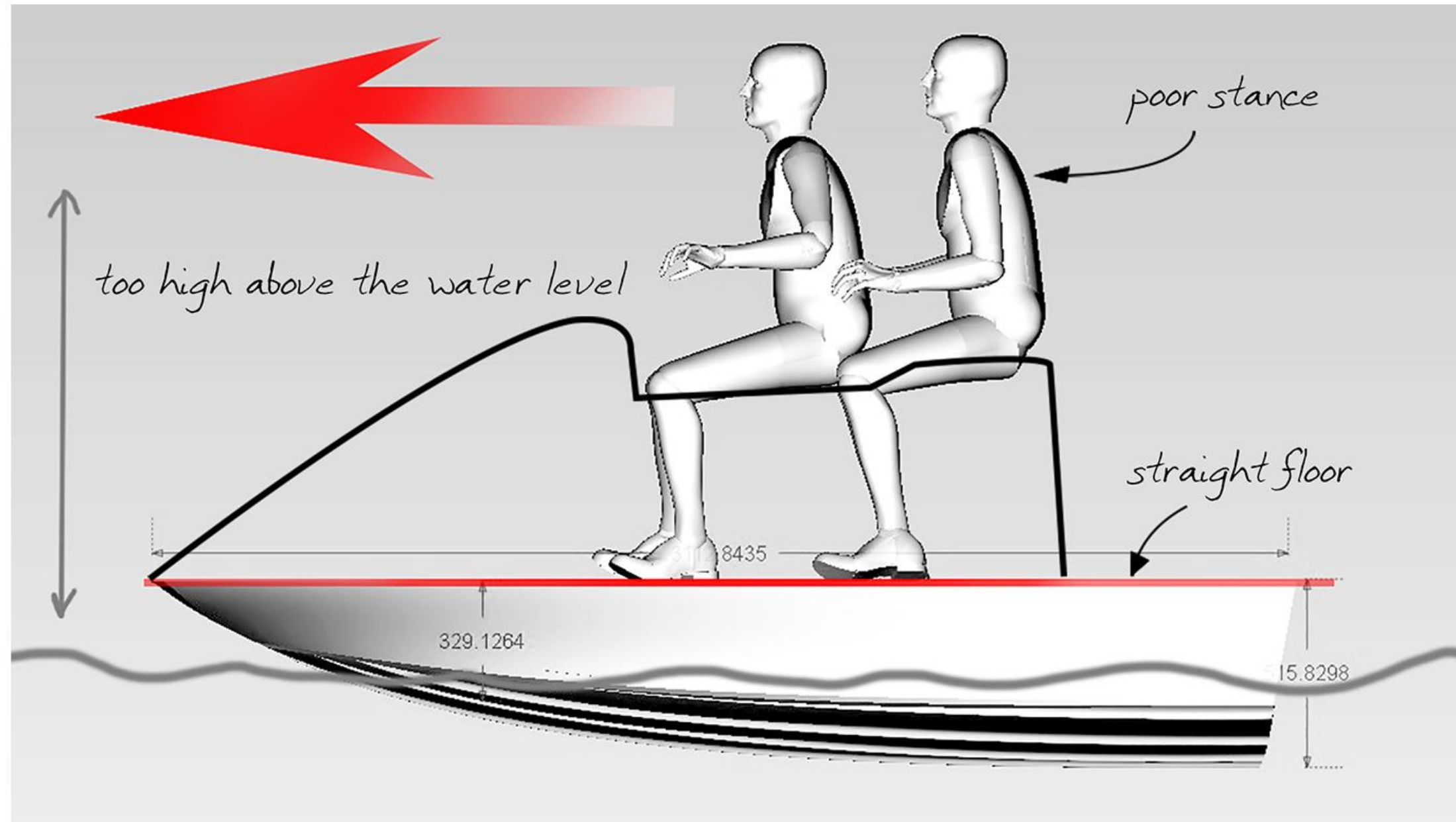

**straight floor**  
**upright stance**  
**higher cg**  
**Poor aggression**

current PWC seating by Samudra

# Riding posture and pillion stance

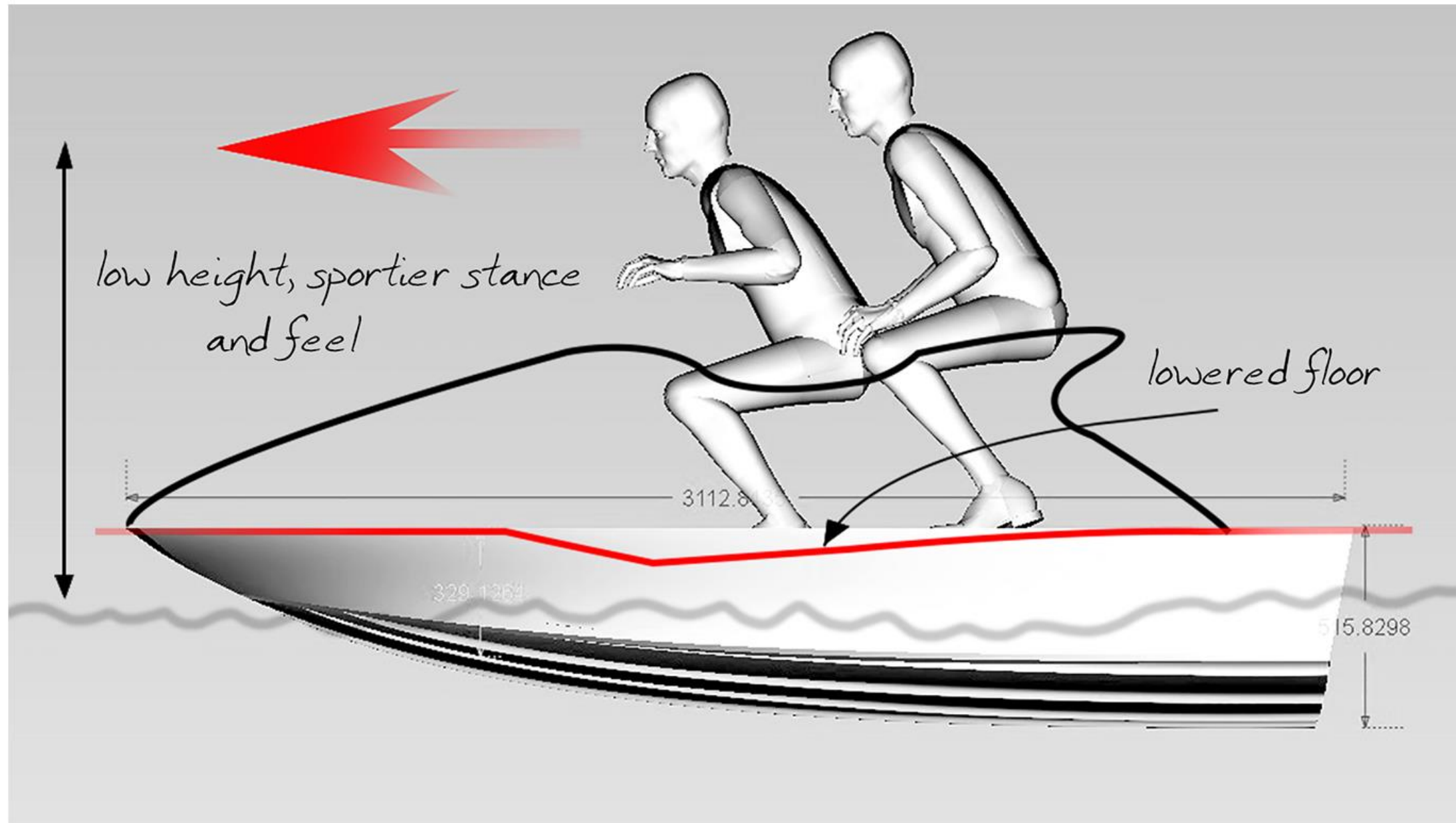

- lowered floor deck**
- crouching forward stance**
- lower CG**
- Better dynamics**

proposed PWC seating

# Moodboard 1



Razor sharp

Aero

edge



# Moodboard 2



Quintessential  
Classic  
Crafted



# Moodboard 3



Sensual  
flow  
organic

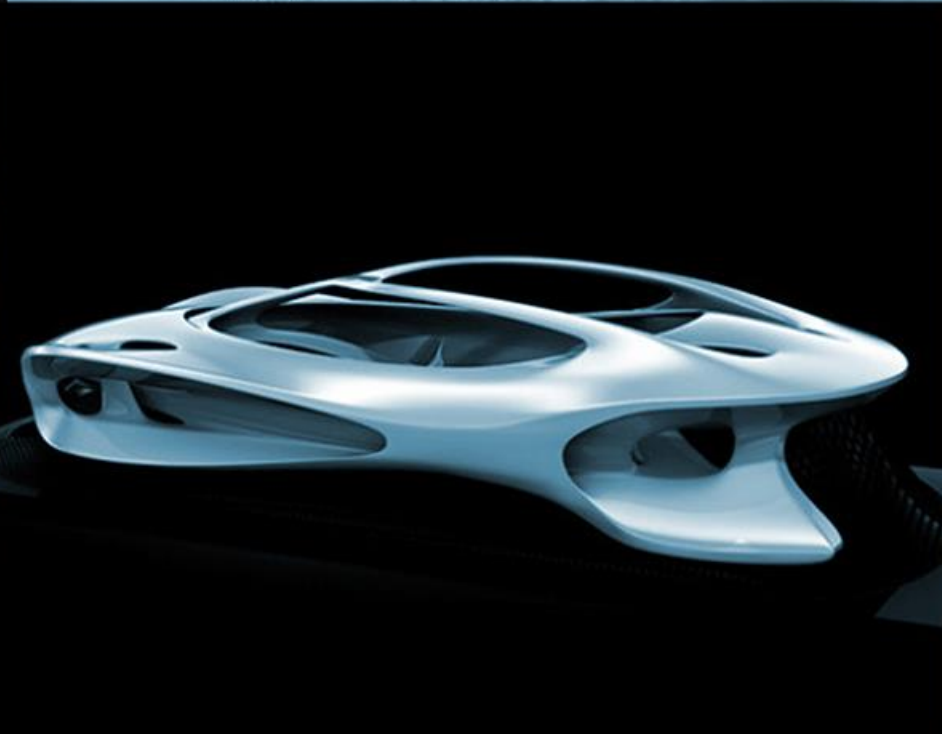
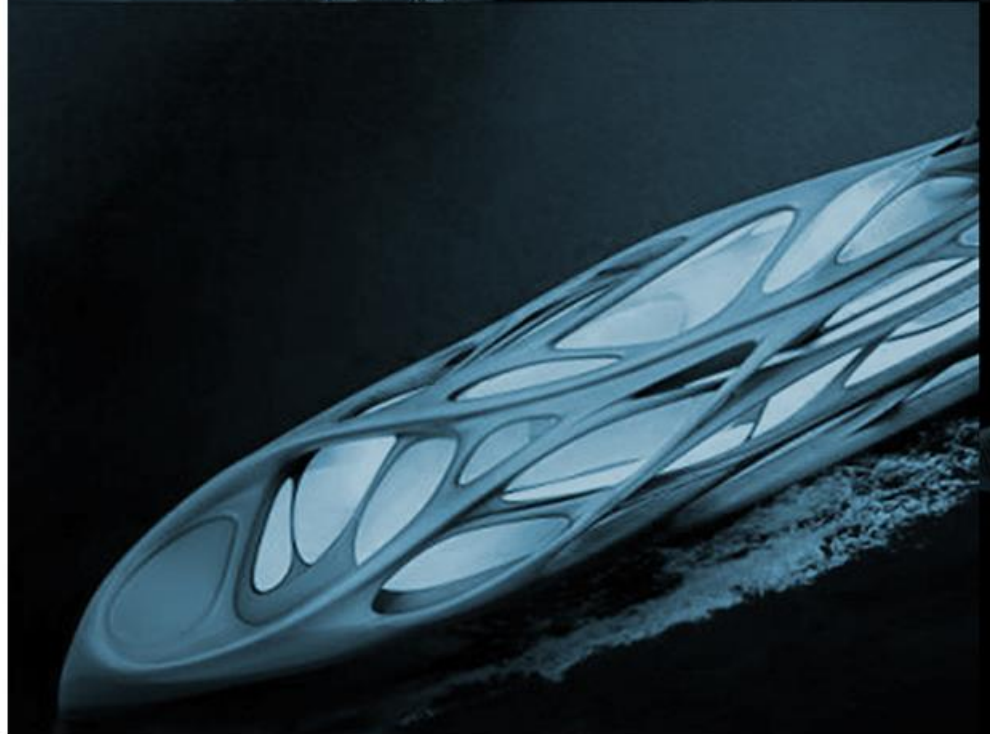

# Form Exploration

Based on the three varied moodboards and the design brief given, the following keywords were determined for form exploration on each moodboard.

## Form Keywords

- **Aggressive** form
- **Sporty** stance
- Freedom
- Comfort



# Form Exploration

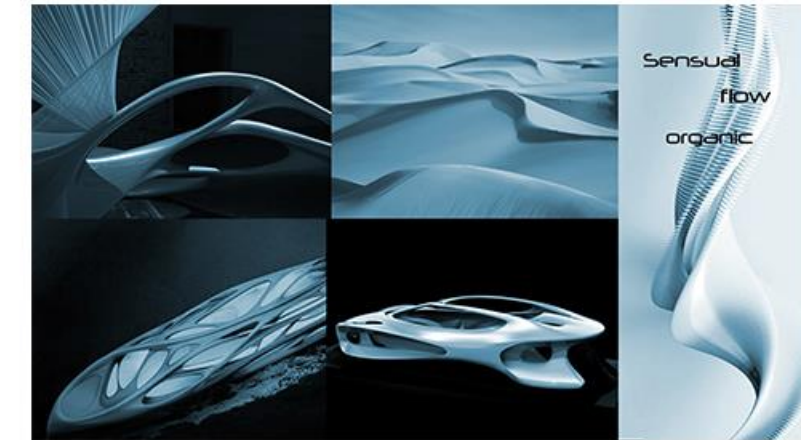
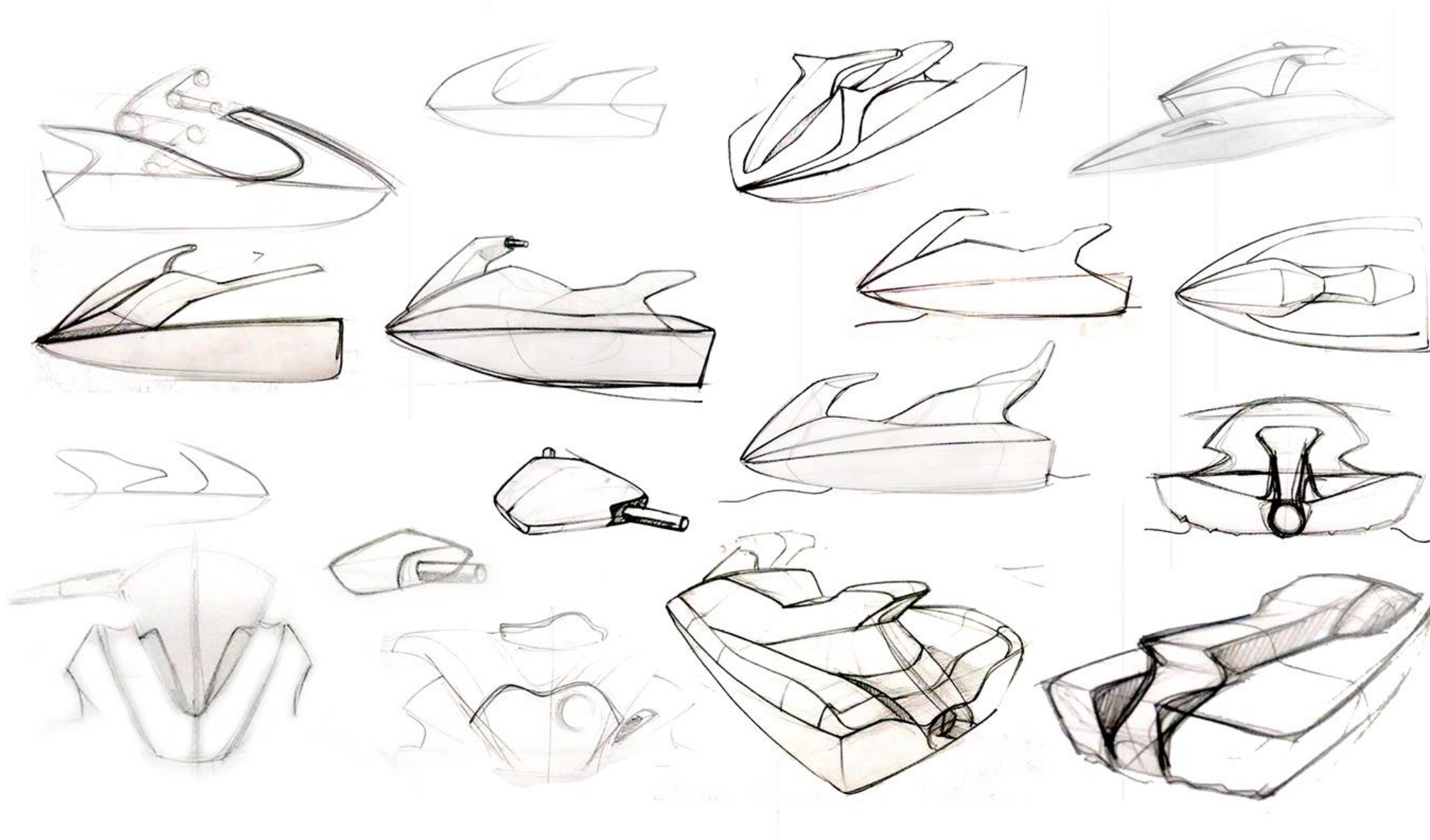

The idea here is to find a form which depicts the ideated mood with continuous flow of lines without any sharp turn of events and emotions.

Organic/flow/sensual form ideations

# Form Exploration

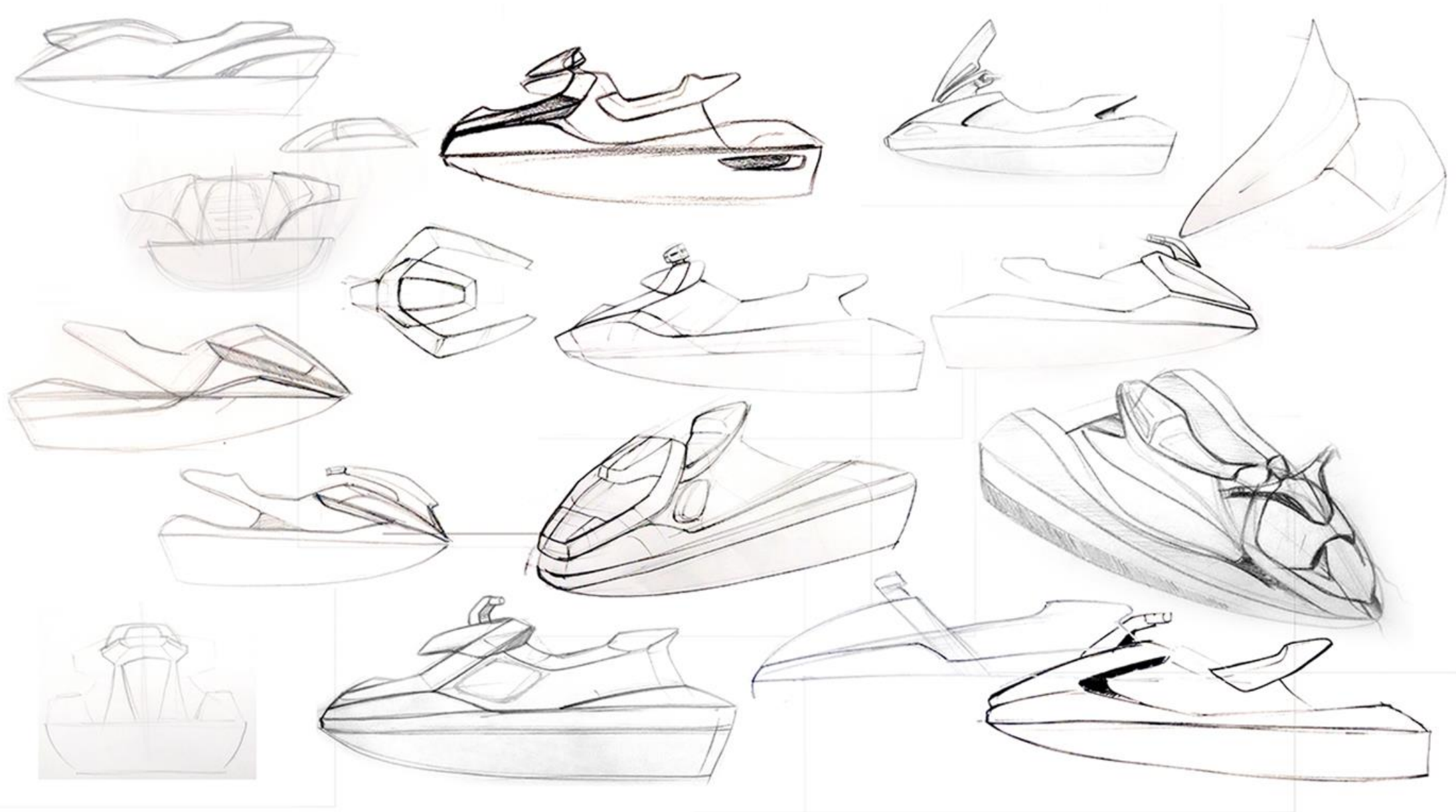

To take influence and inspiration from crafted forms, to give the jet-ski a feel of richness and delicately crafted appeal.

Quintessential/Classic?Crafted

# Form Exploration

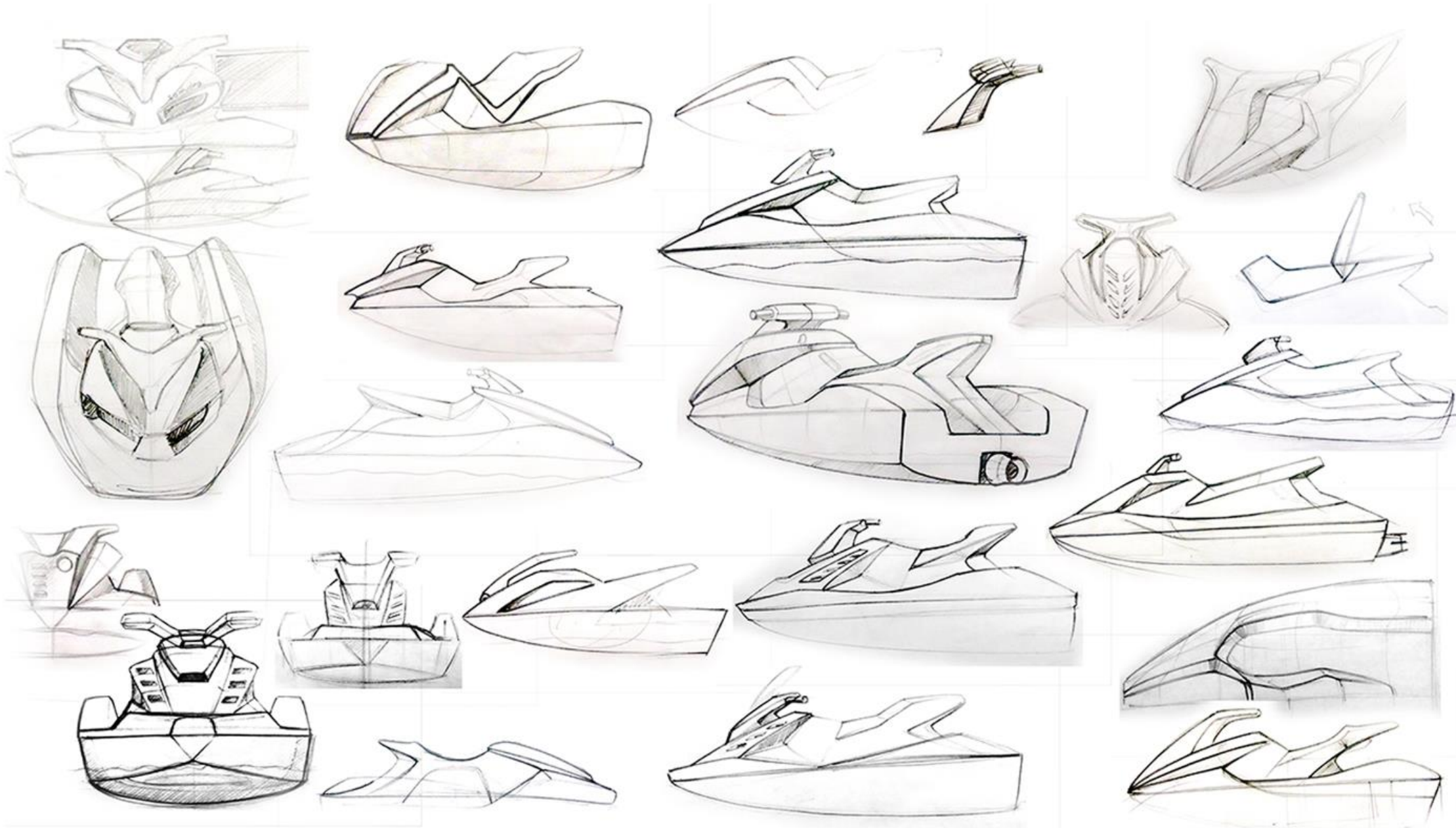

Razor Sharp/Aero/Edge



Three keywords; razor sharp, aero and edge is the main soul behind the ideations of this form exploration. A sync, blend between youth and sobriety.

# Final Direction

Based on the three moodboard ideations presented to the Samudra Shipyard management team, it was fixed that the **Razor sharp/Aero/Edge** theme suited more according to their need.

This form would appeal more to the prospective buyers.

Has that edge of youth and sporty character to connect to the riders as well as the onlookers.

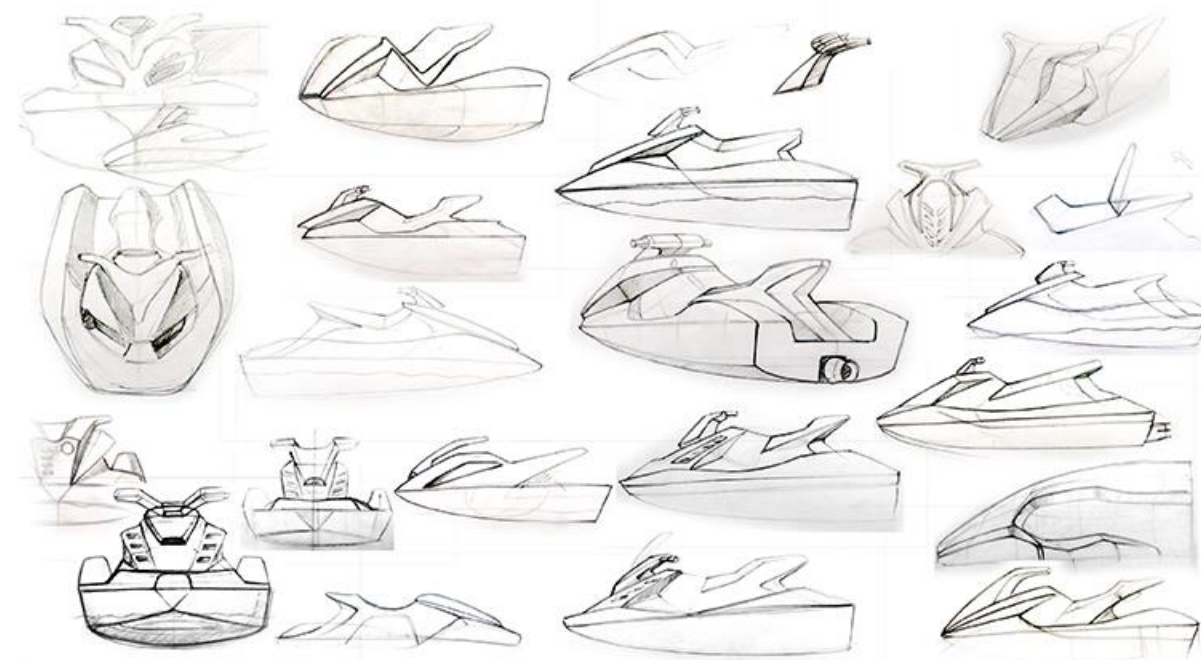

# Final ideations

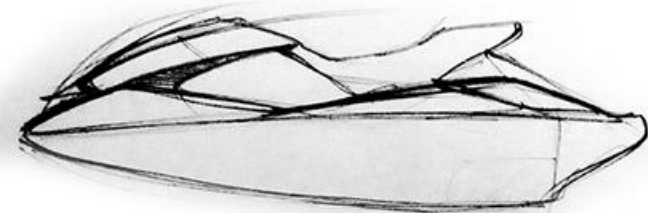

digital information console

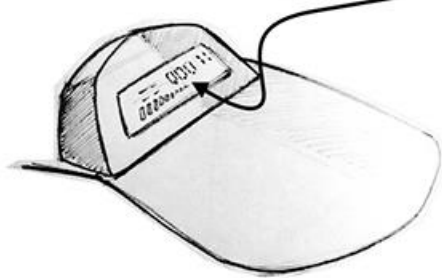

streamlined form

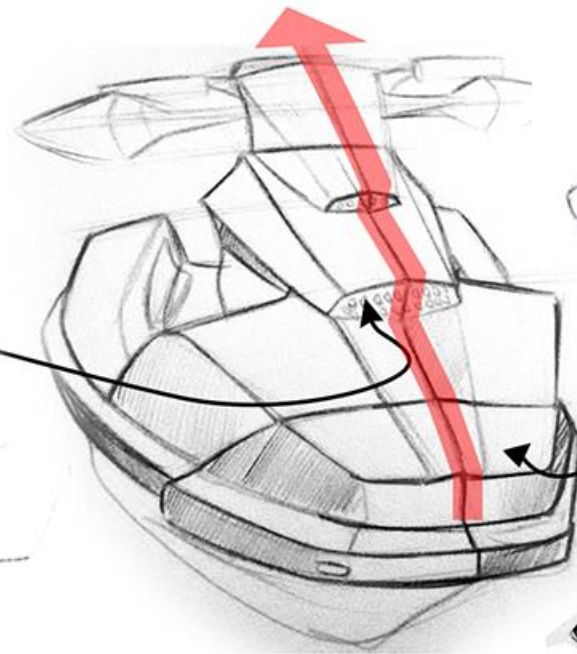
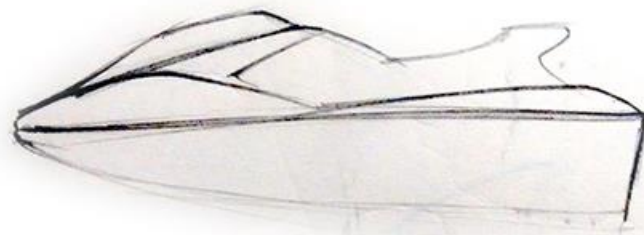

Air vents for engine

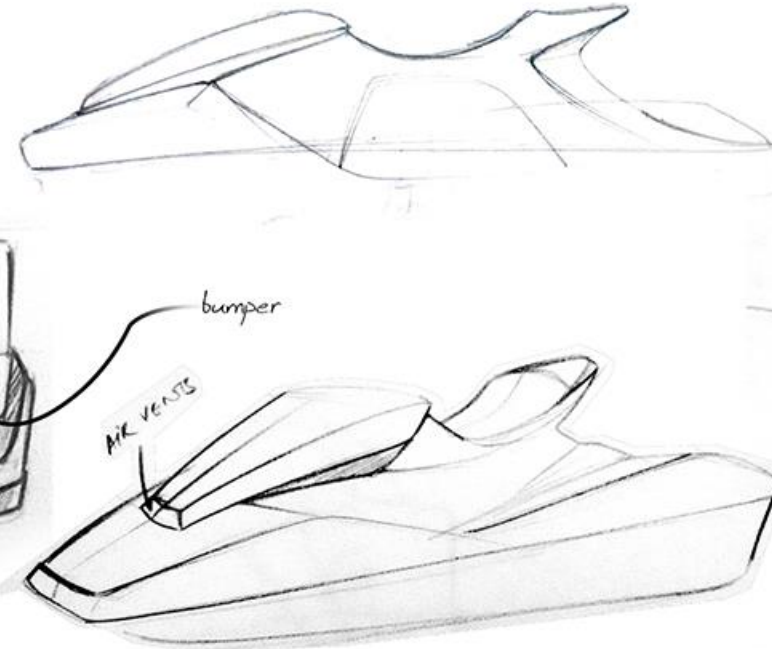

bumper

AIR VENTS

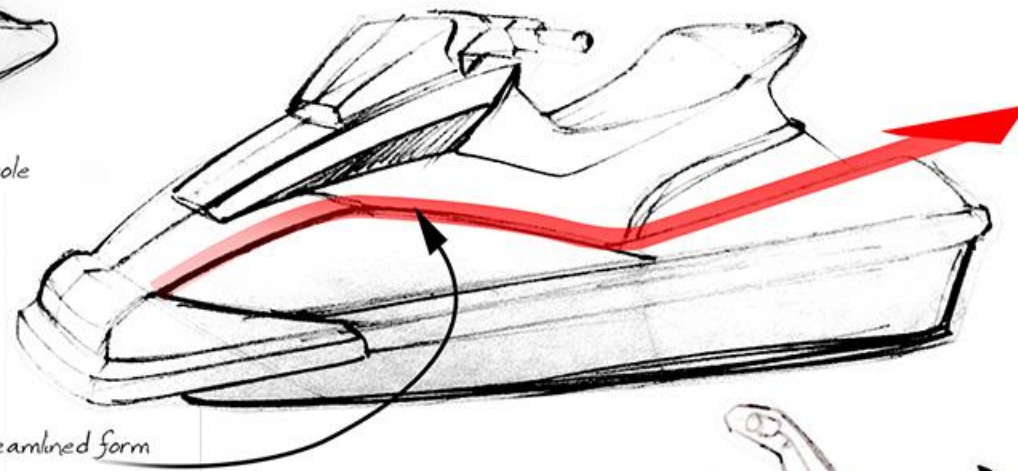
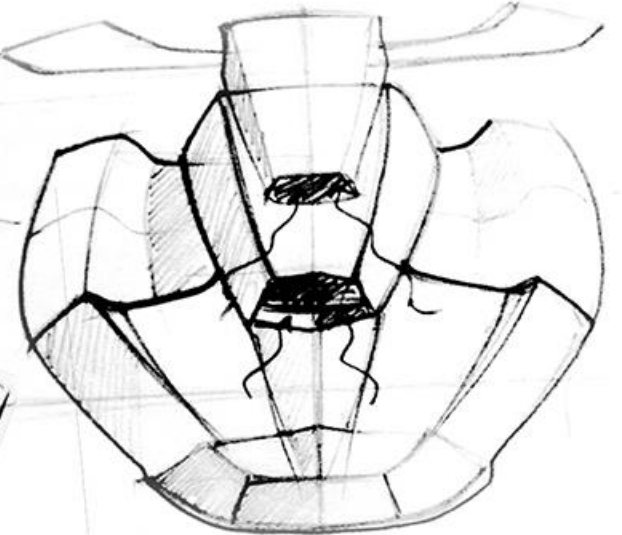

aggressive nose

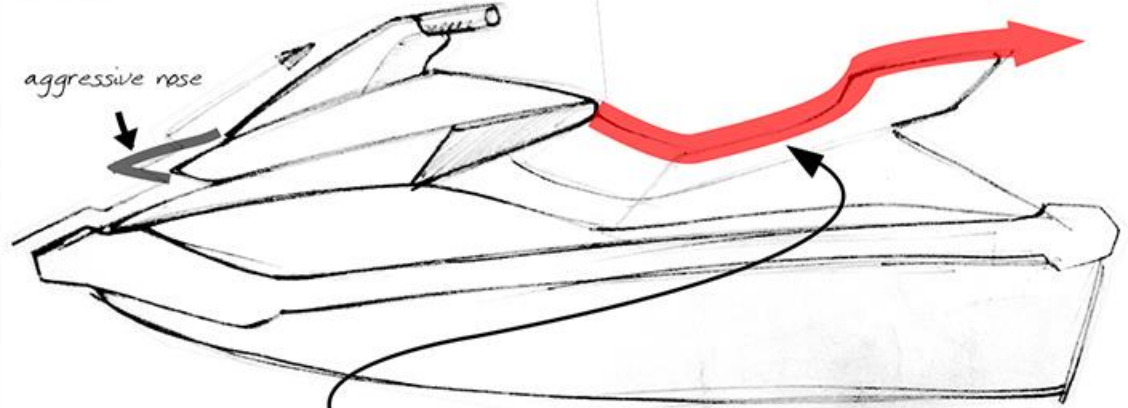

sporty seat profile with back support

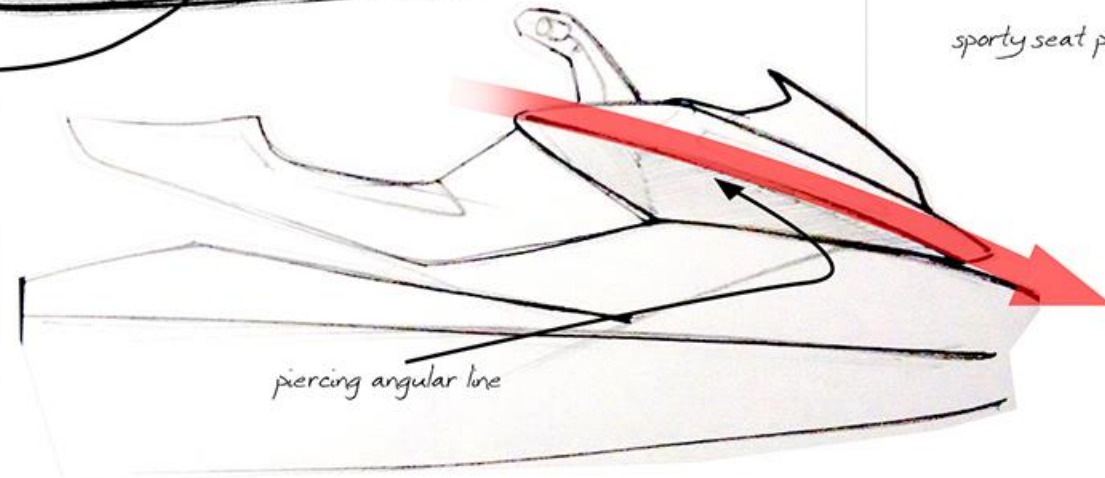

piercing angular line

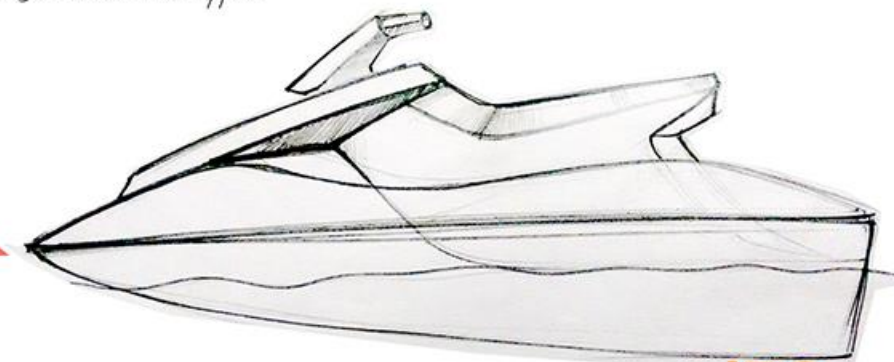

# Final Render

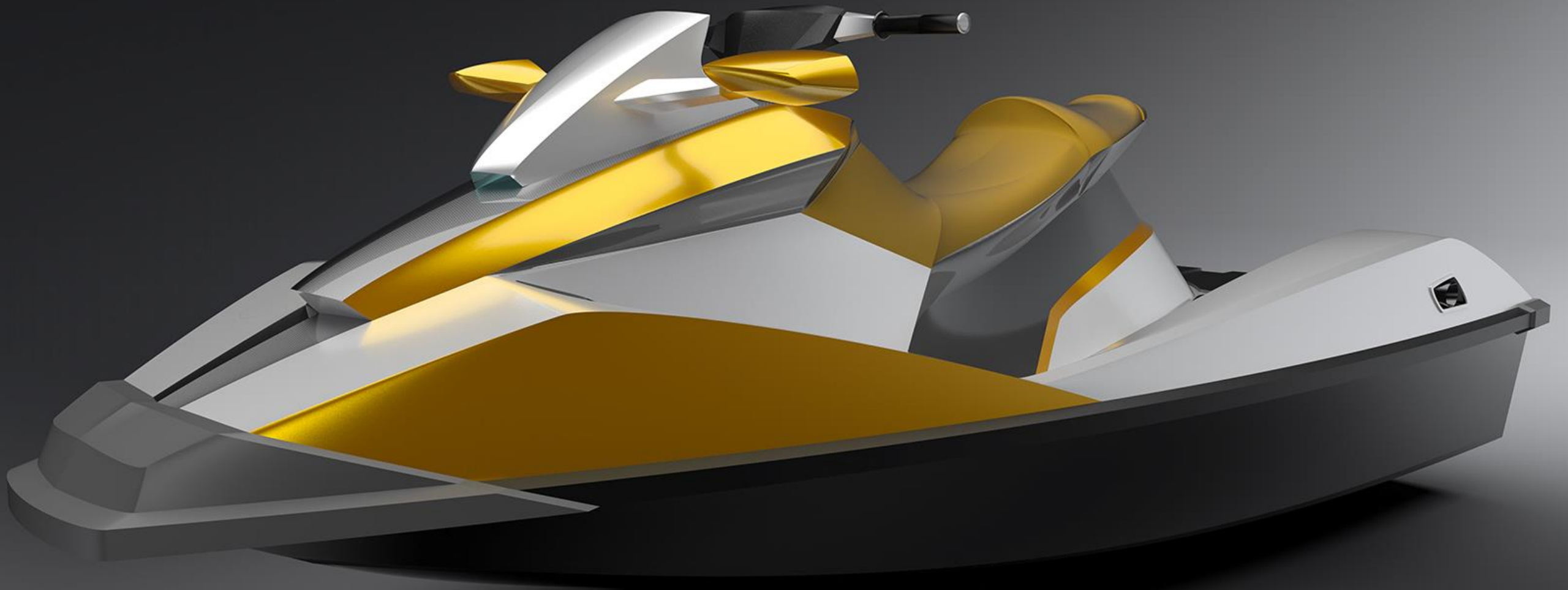

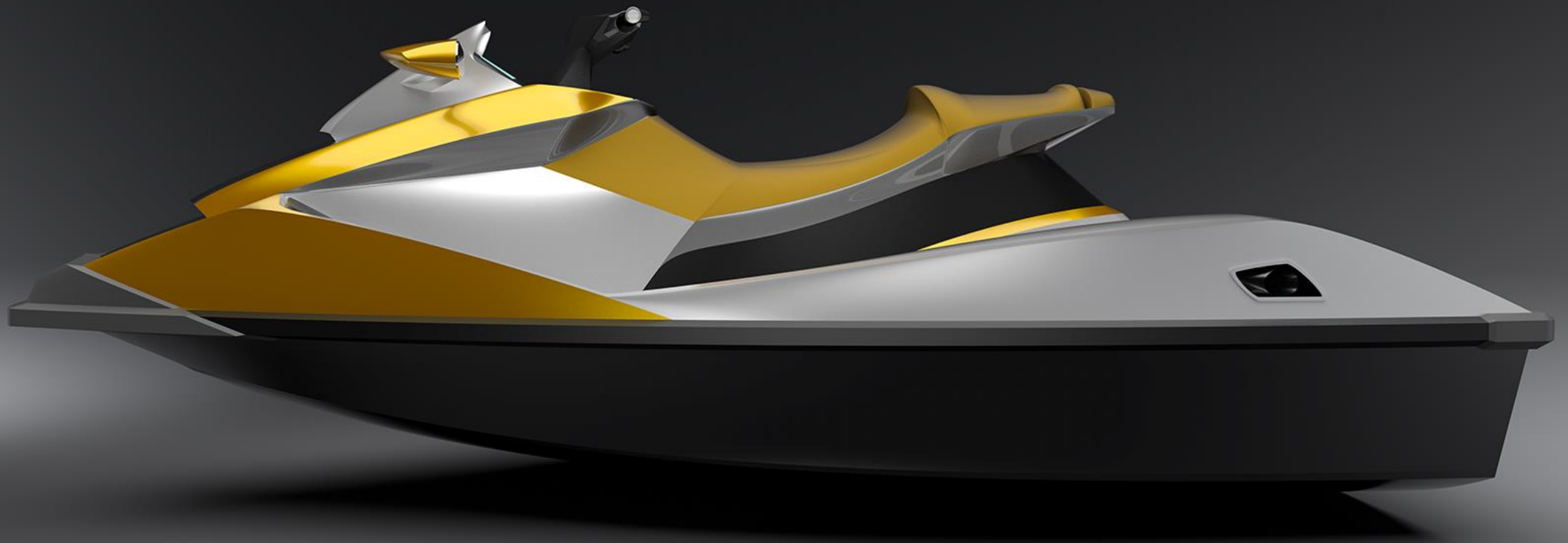



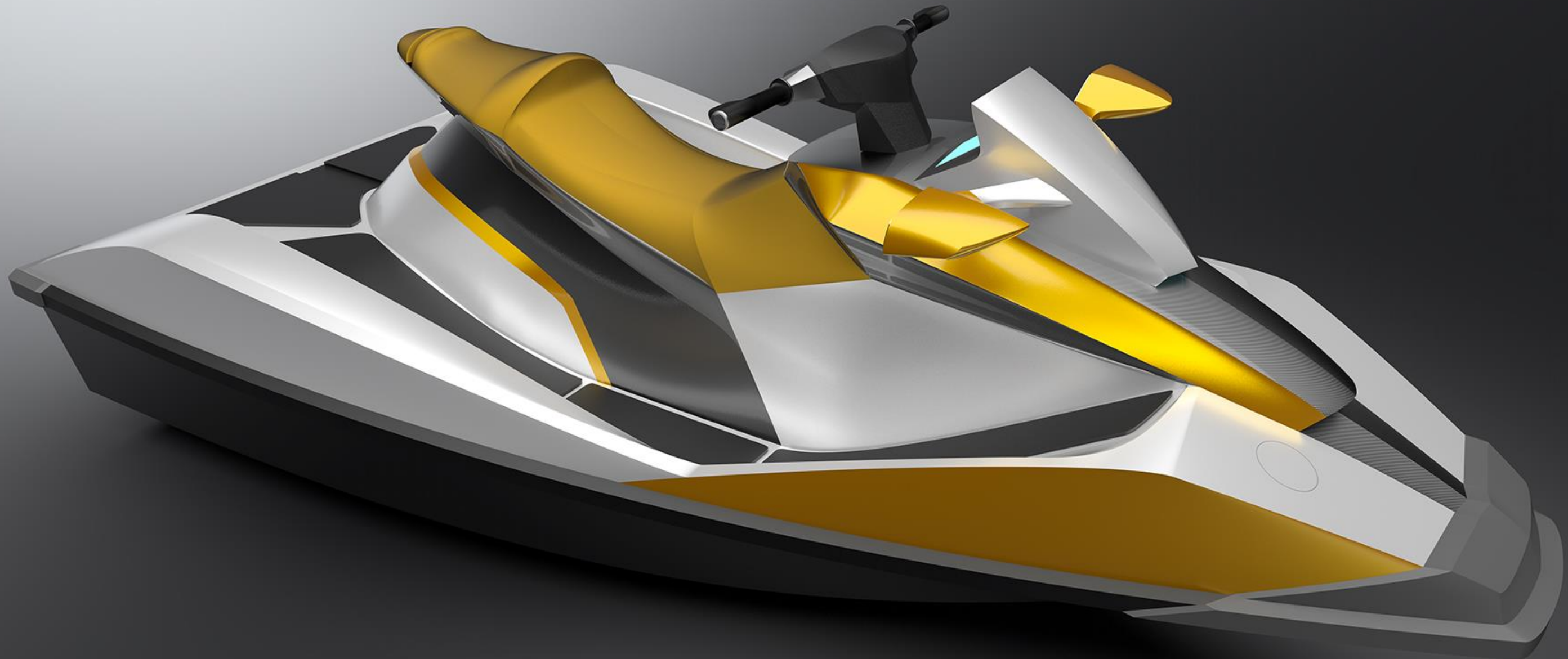

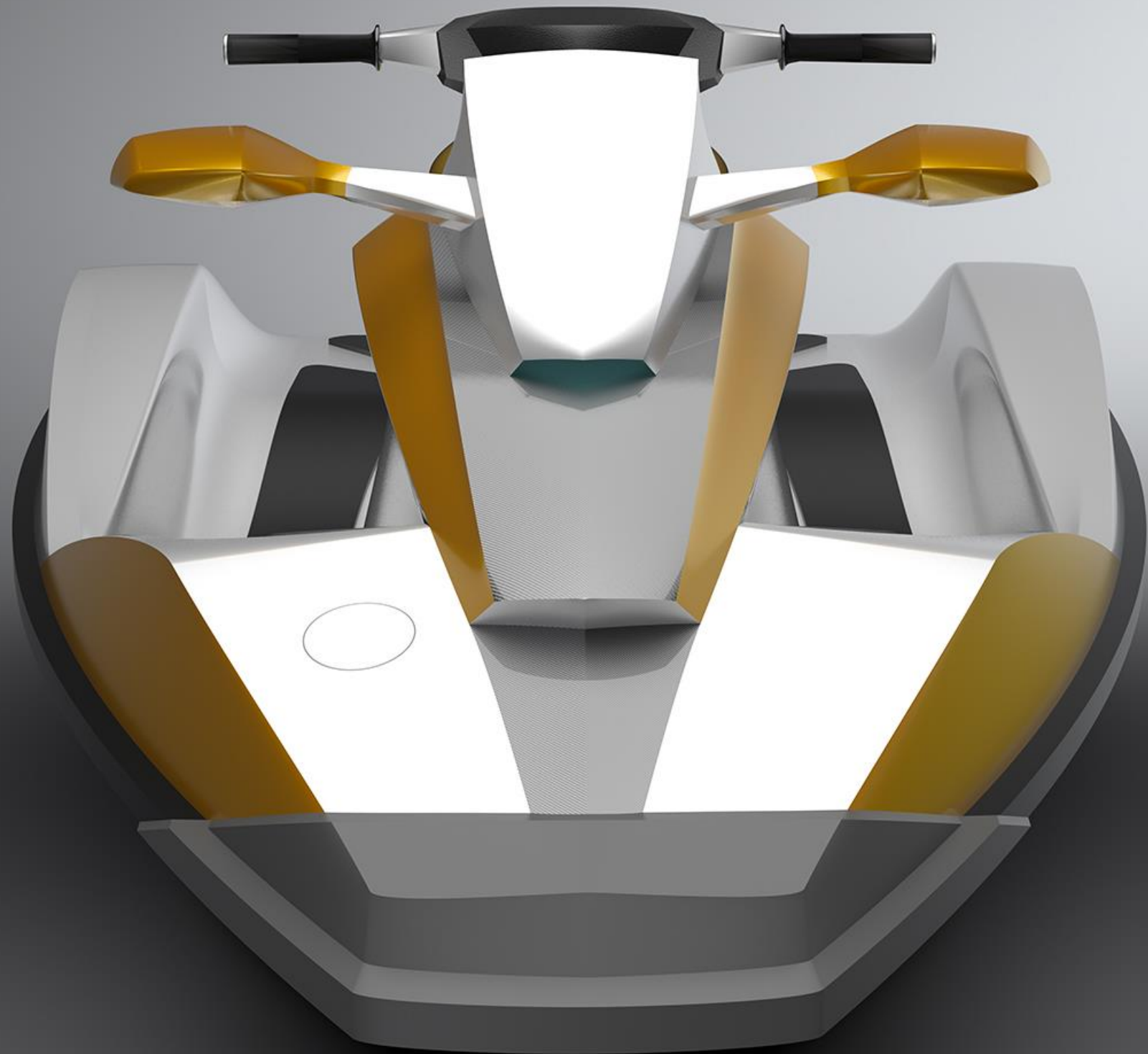



**Modular floor mat**

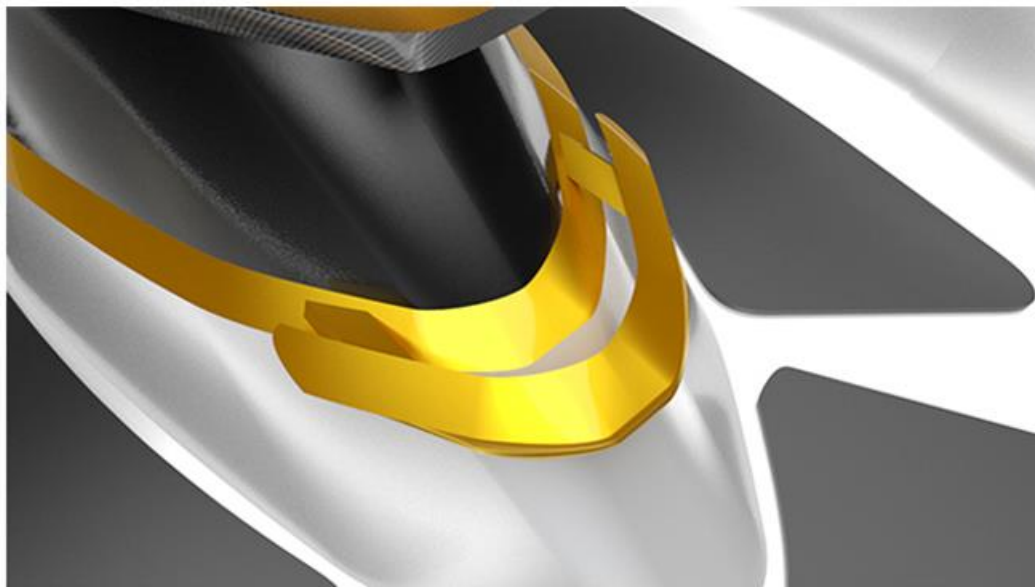

**Pop-out grab handle**

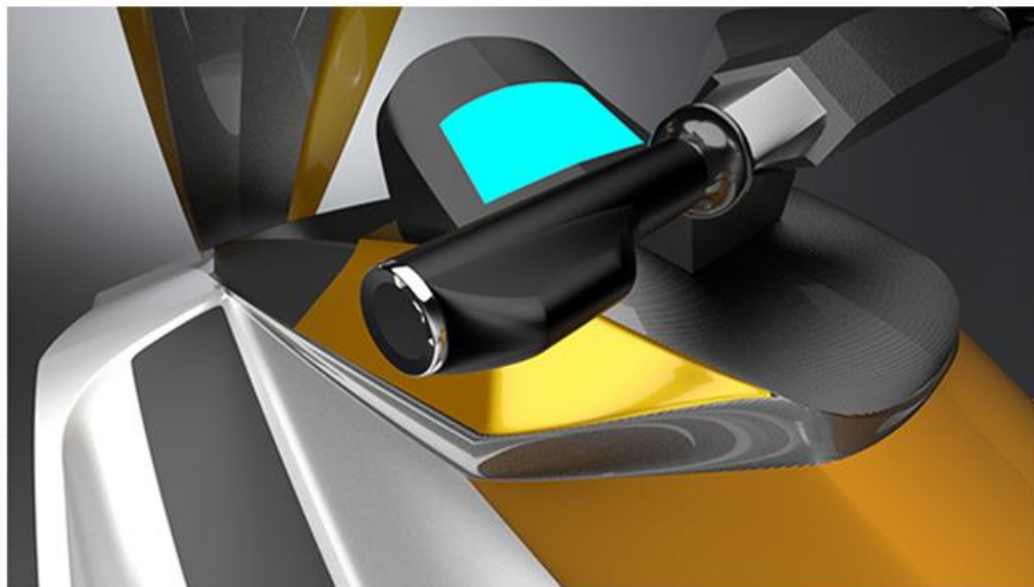

**Digital console**

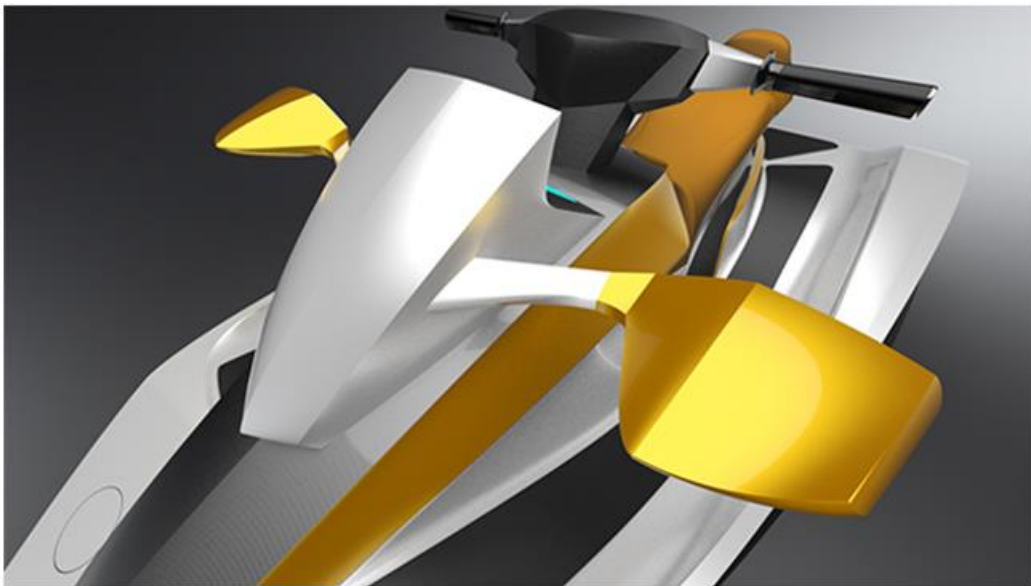

**Dual rear view mirror**



**Convenient storage**

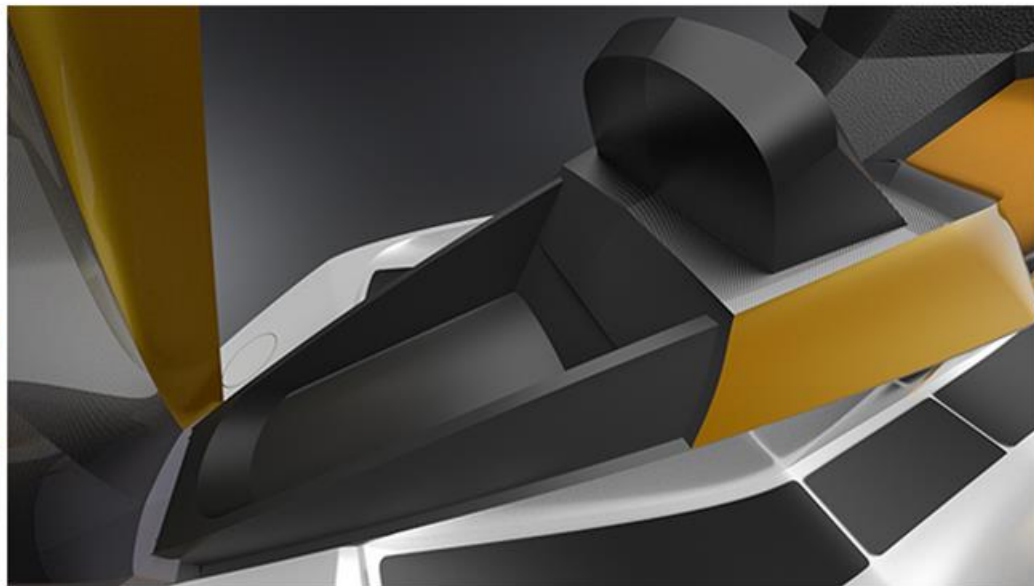

**Deep glovebox**

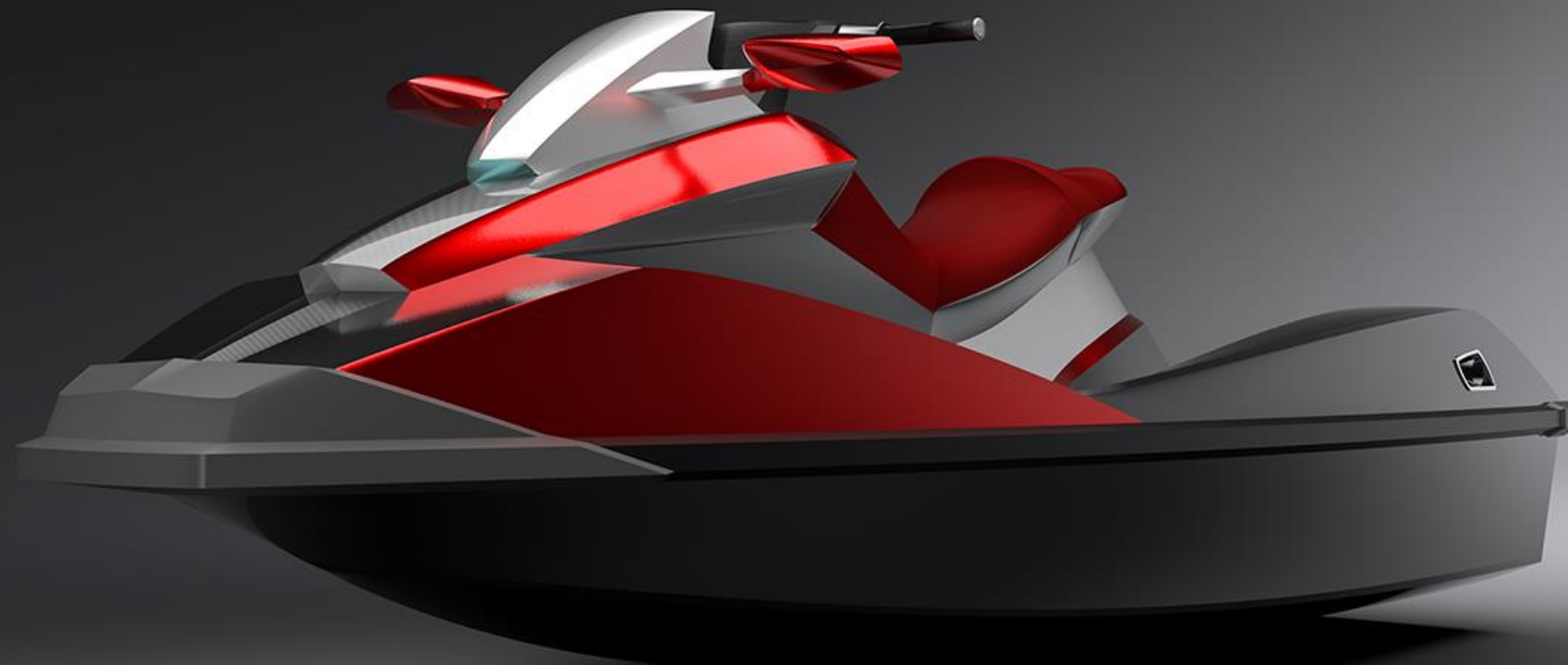

Pleasure!

**IDC**  
IIT Bombay