

DE 608: PRODUCT DESIGN -2

# **WOODEN TOY DESIGN FOR KIDS (9-15 MONTHS)**

P SRI HARI  
176130008

# 1. What is the product?

- ✓ A toy that mimics the shape/ motion of a creature/object in the nature.
- ✓ Actuation mechanisms are introduced to mimic the functions of natural objects like walking, talking, making expressions and exhibiting behavior.

## 2. Aims or goals:

- ✓ To design a toy that can be **mass produced** with an affordable cost
- ✓ Age appropriate toy
- ✓ **Child safe toy**( Toxic free materials)
- ✓ **Well made** (No sharp edges, paint peeling etc..,)

### 3. Research Findings:

- The toy should be **safe** for the kids – form, material and size of parts, etc.
- The toy should be **easy to operate** and visually approachable.
- The toy should be able to **withstand wear and tear**

## Design Inspiration:

**Dogs** are animals, but they have a special place in the hearts of many adults and children. If appropriately trained and supervised, dogs can provide many valuable lessons and other benefits to children.



Figure 2: Relation between babies and dogs. Accessed on 10 April, 2018 <<https://www.boredpanda.com/kids-dogs-friendship/>>

# DOGS MOOD ANALYSIS:

Observing the “whole dog” at a distance can give you a quick and general idea of the dog’s mood.

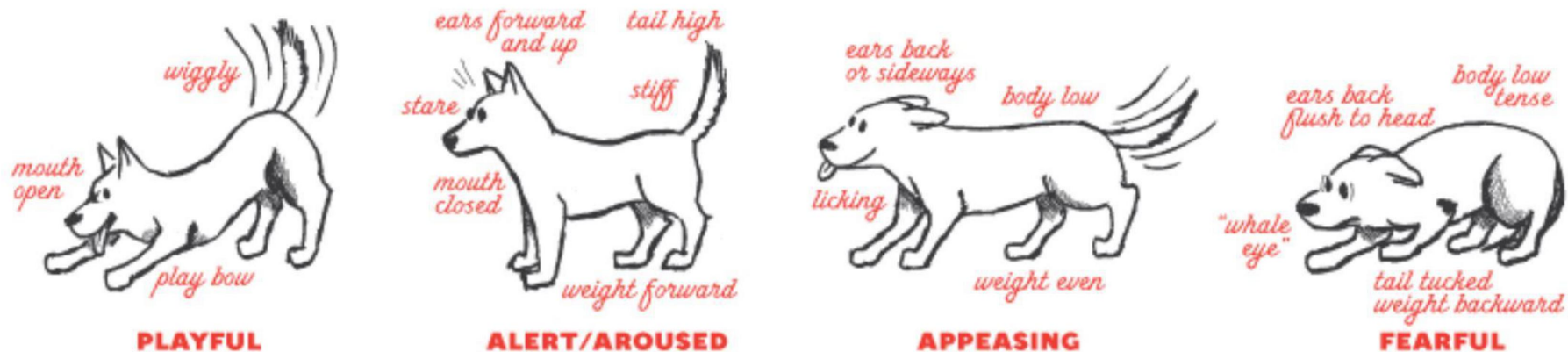

Figure 3: Mood analysis of dogs. Accessed on 10 April, 2018 <<http://www.beautifulbeasties.com/learning-to-speak-dog-part-4-reading-a-dogs-body/>>

Once you have a general idea after observing the dog as a whole, you can zoom in on individual body parts that will often give you key clues on the dog's emotional state.

## EARS:



Figure 4: Mood analysis of dogs based on ears. Accessed on 10 April, 2018 <<http://www.beautifulbeasties.com/learning-to-speak-dog-part-4-reading-a-dogs-body/>>

# TAIL:

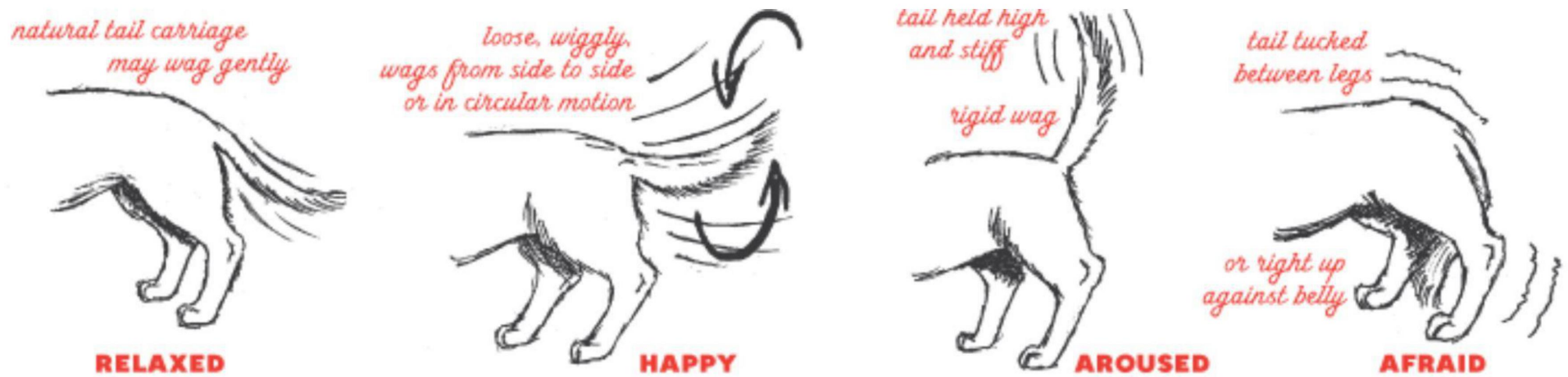
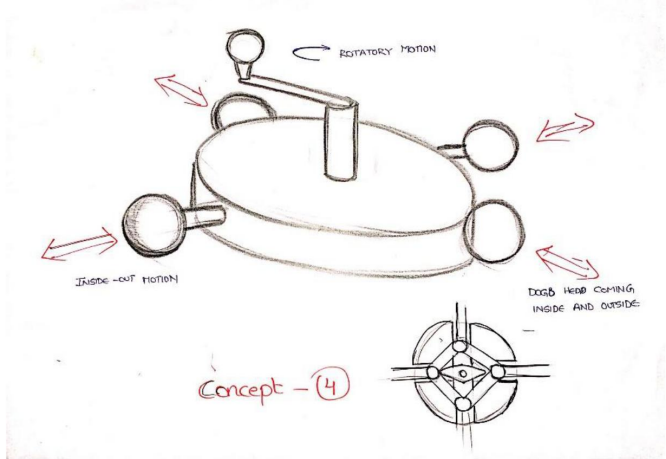
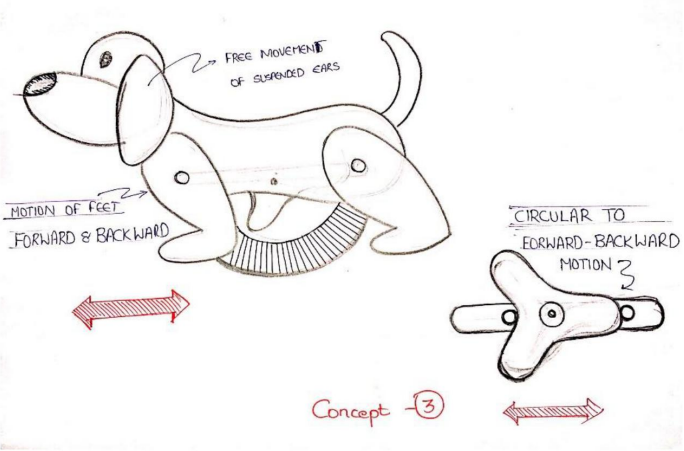
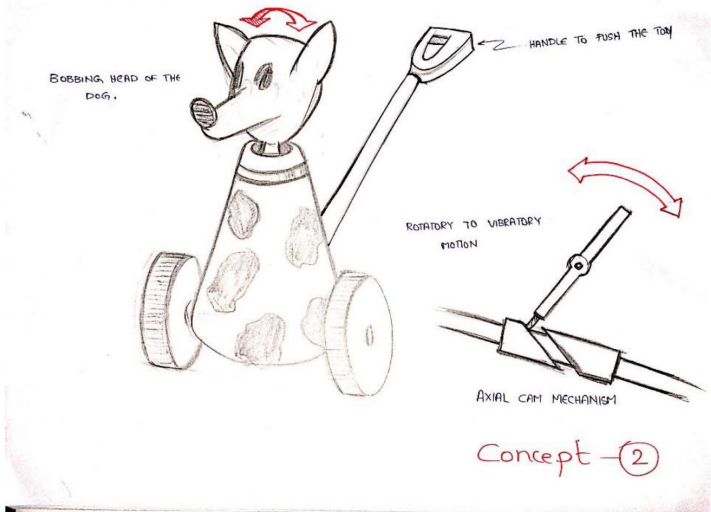
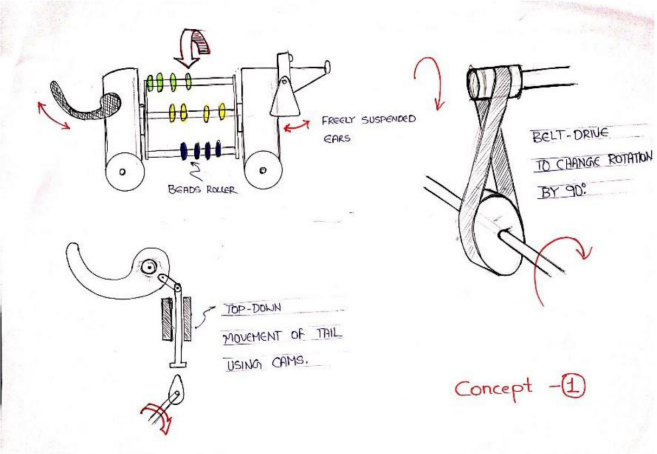
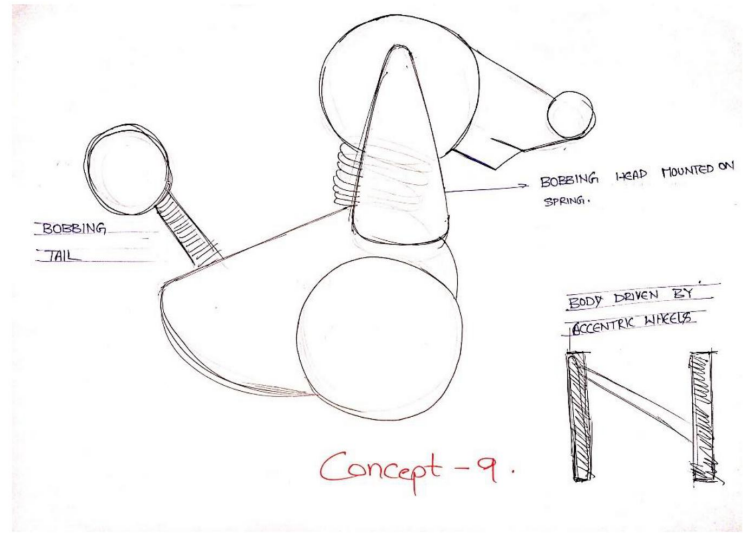
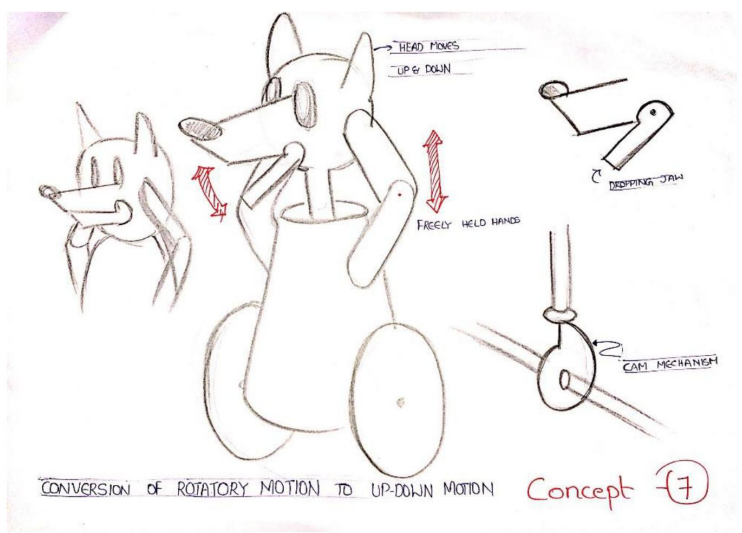
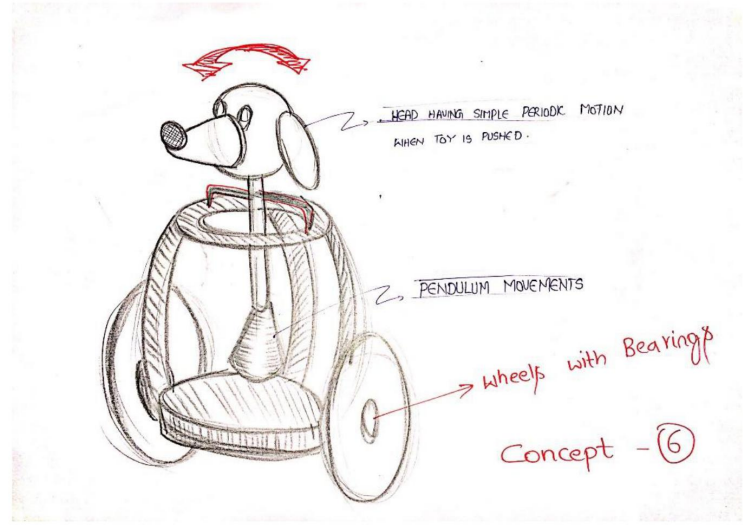
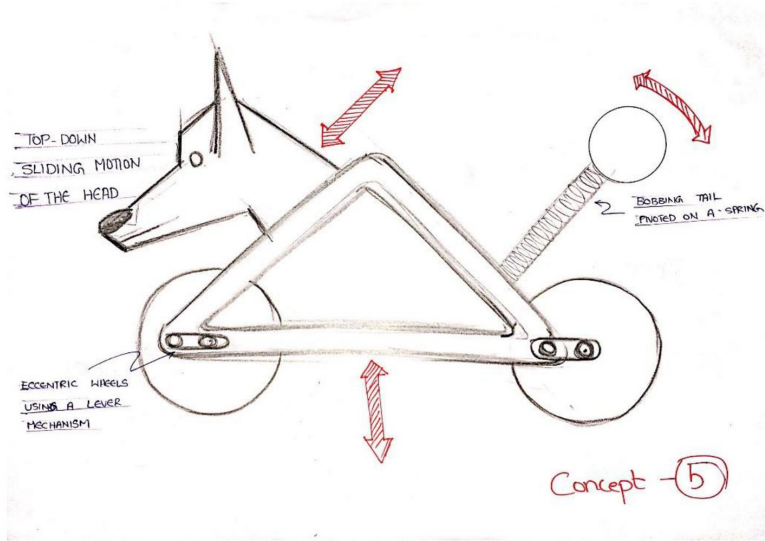

Figure 6: Mood analysis of dogs based on tail. Accessed on 10 April, 2018 <<http://www.beautifulbeasties.com/learning-to-speak-dog-part-4-reading-a-dogs-body/>>



# Initial Concepts:





# MECHANICAL MOVEMENTS:

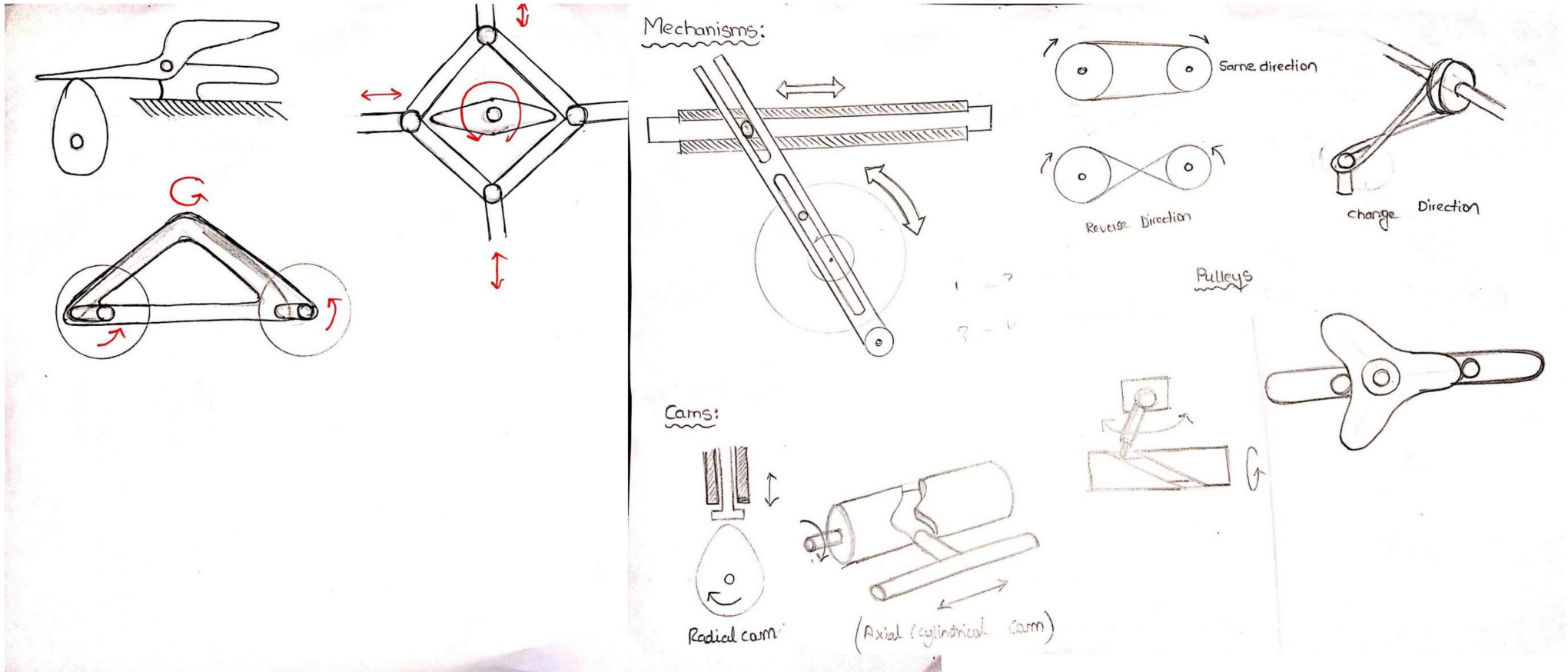

# PROTOTYPES:

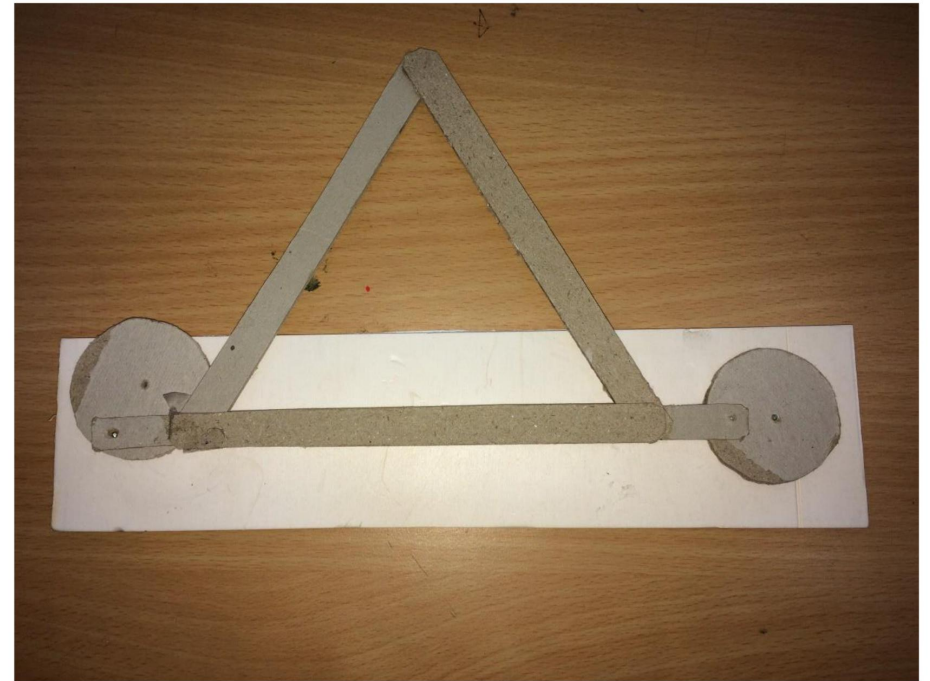
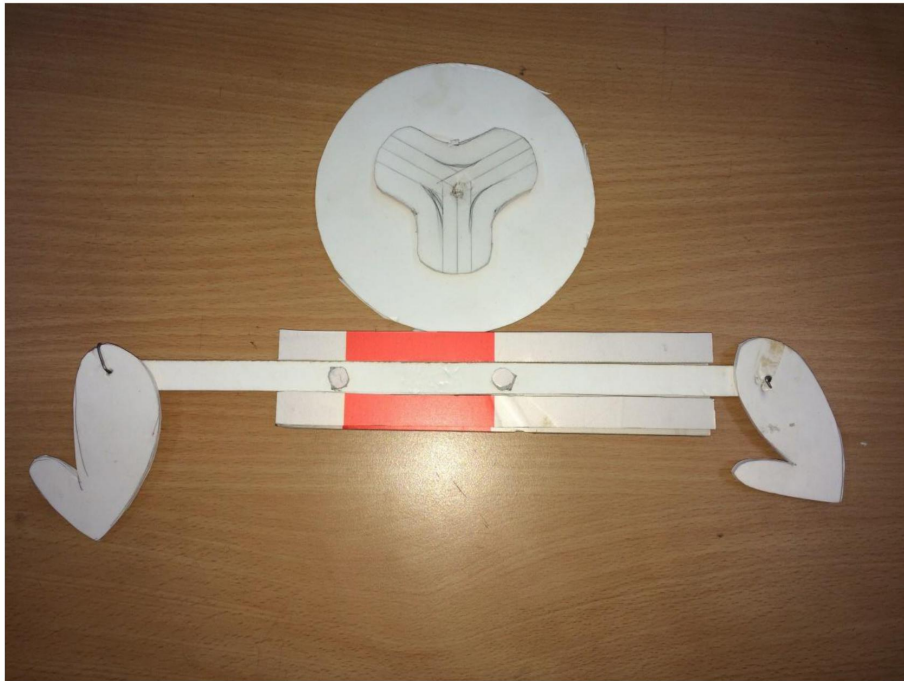

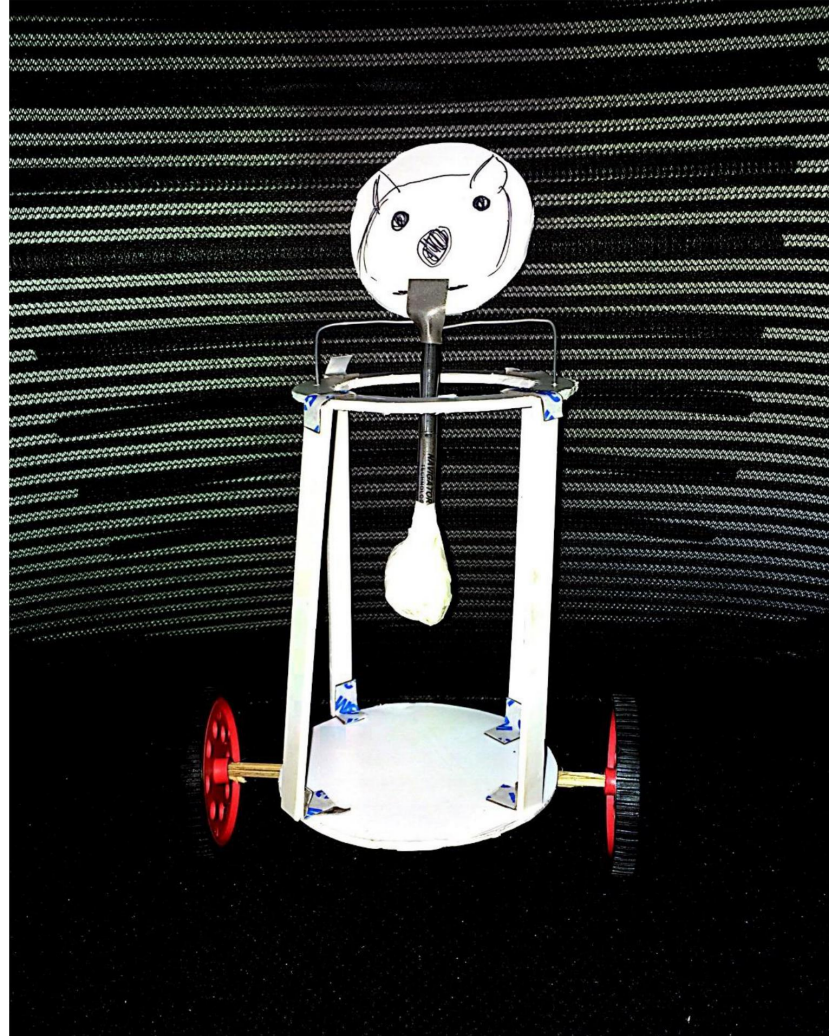

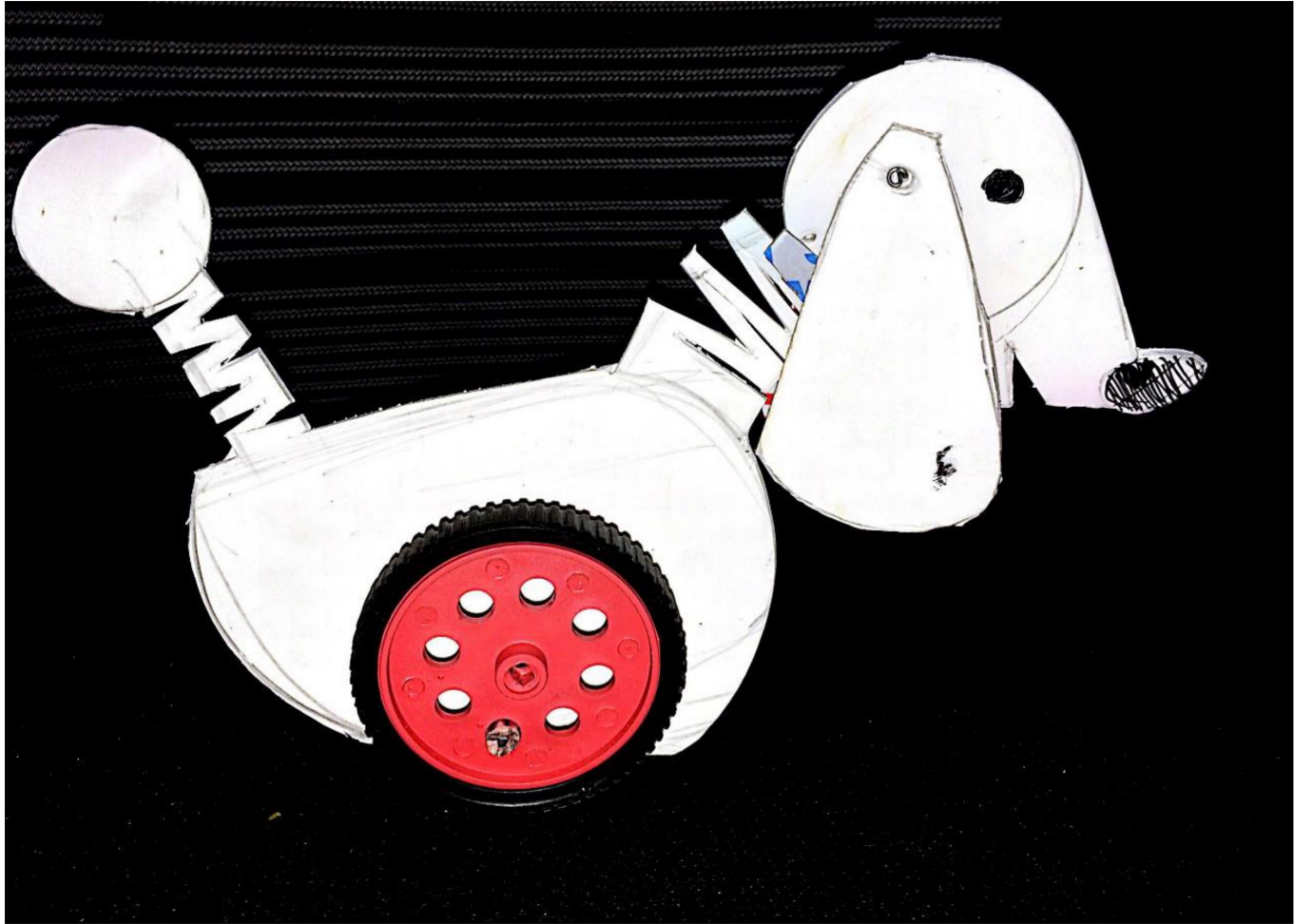

**MOCKUP:**

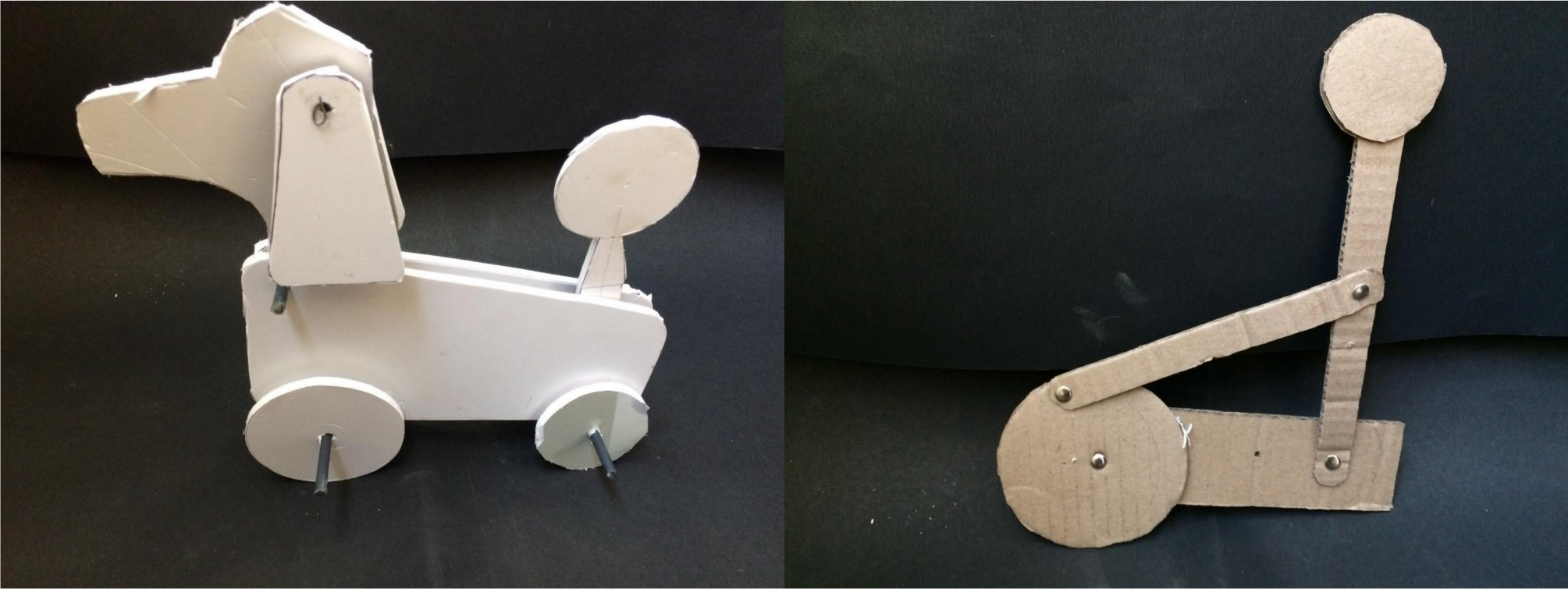

## COLOR VARIATIONS:

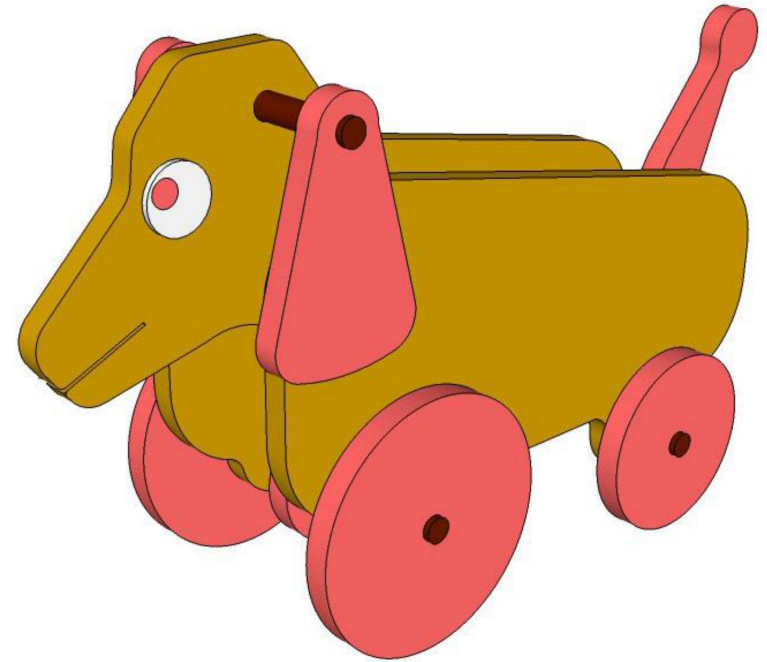
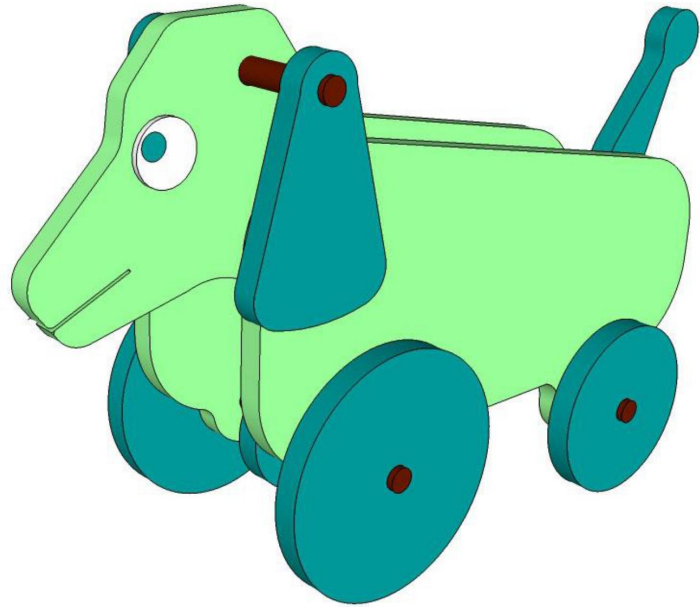



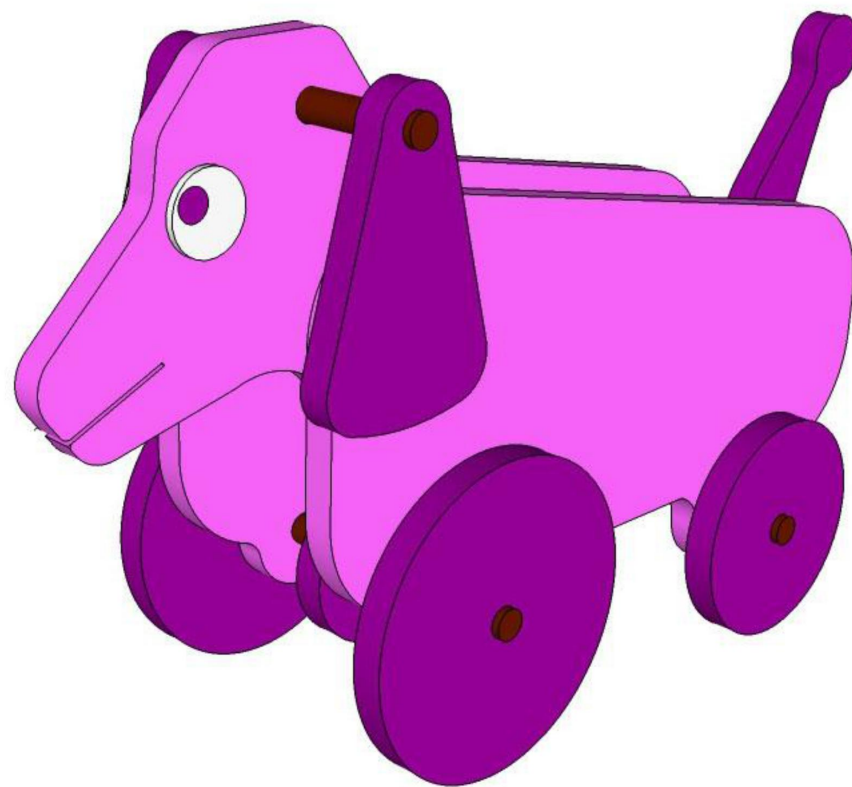
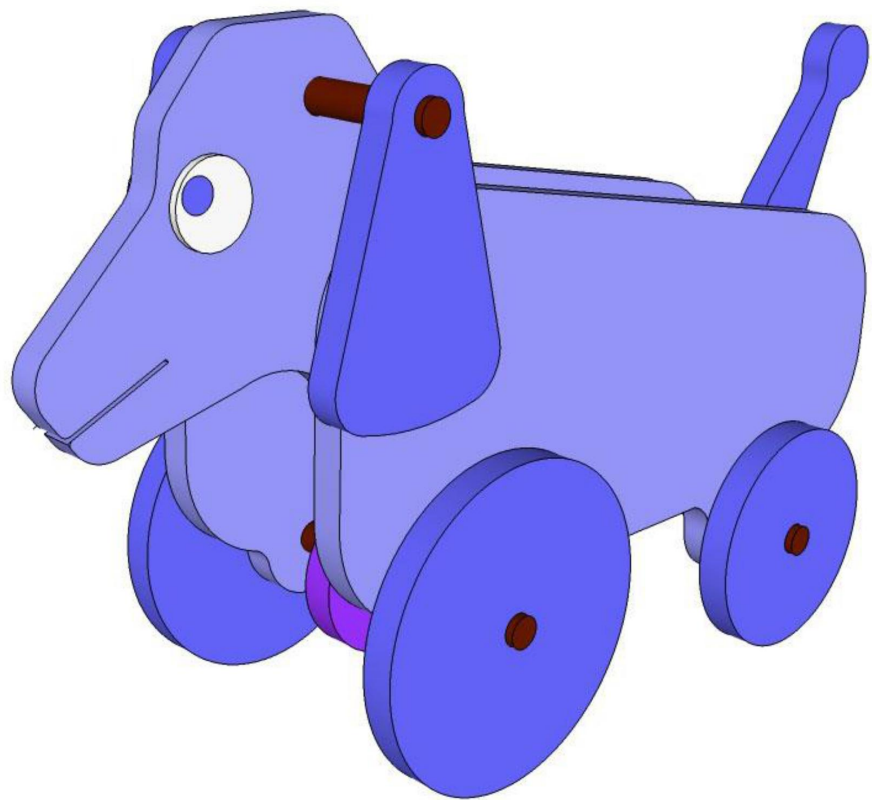

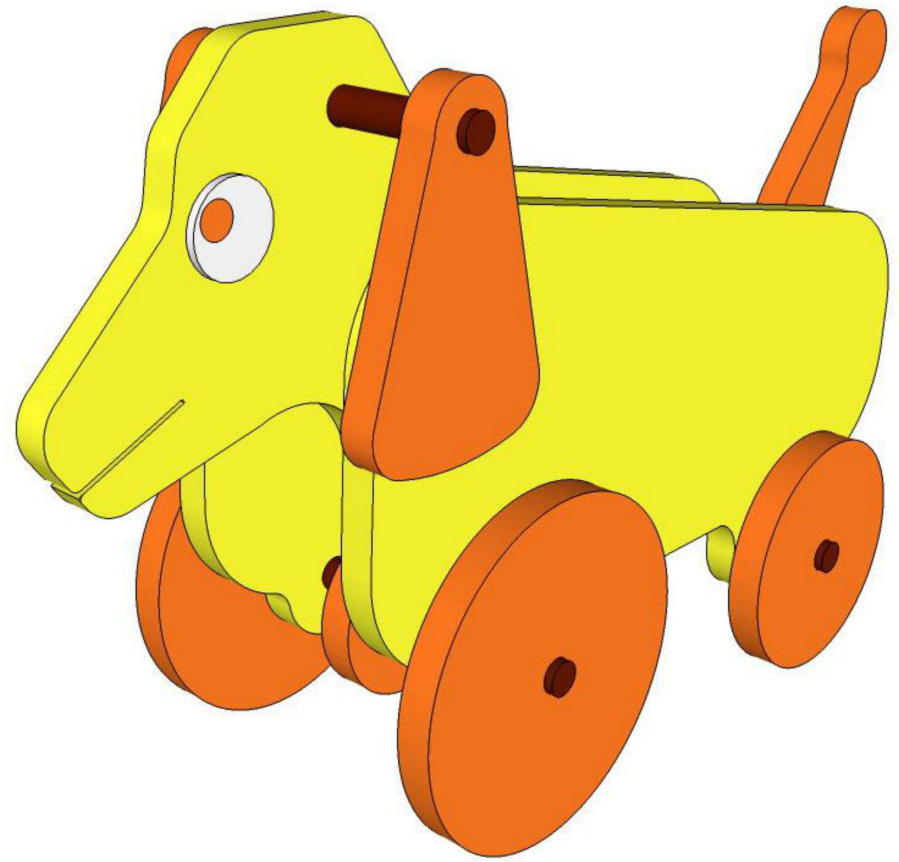
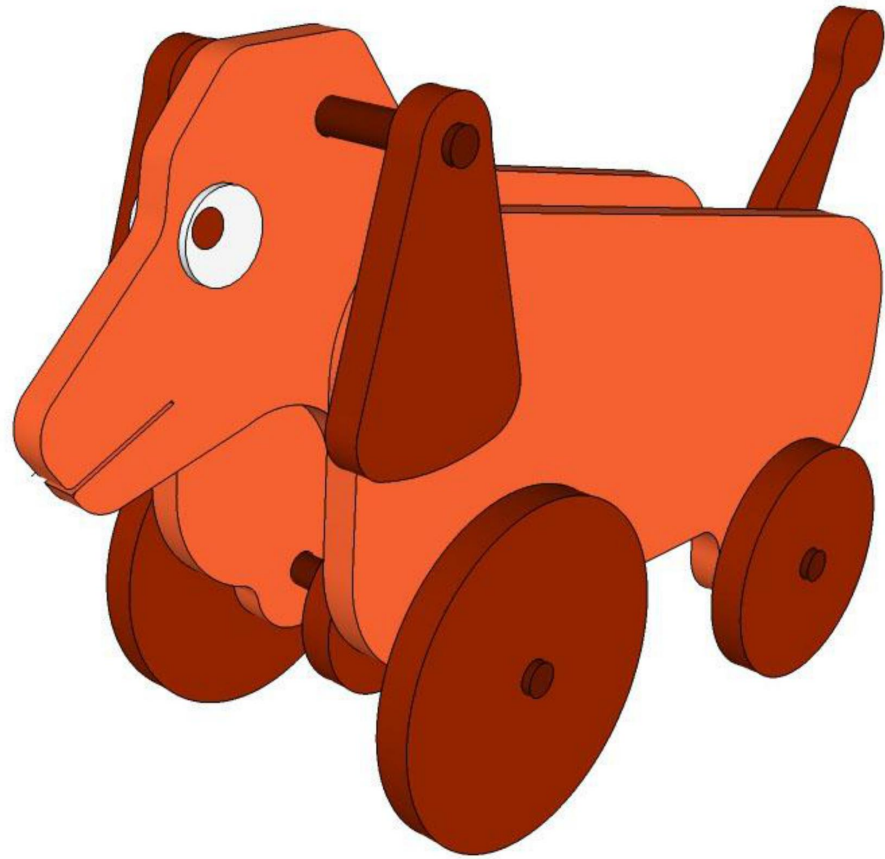

## 3D MODEL:

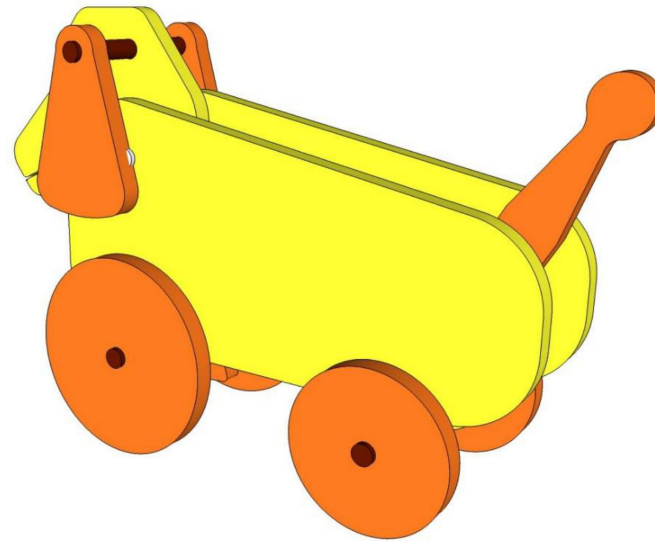
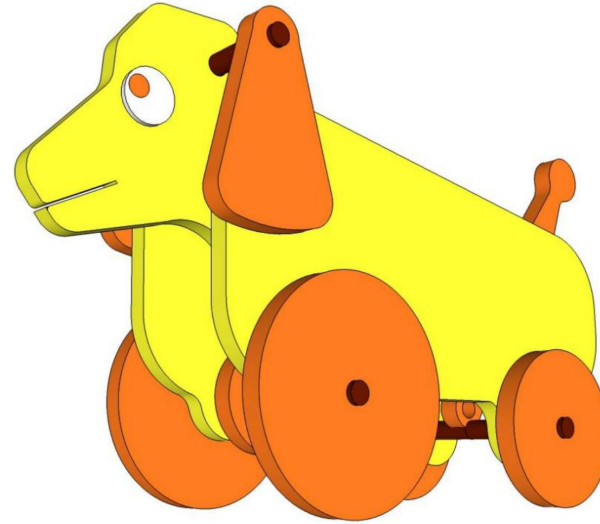
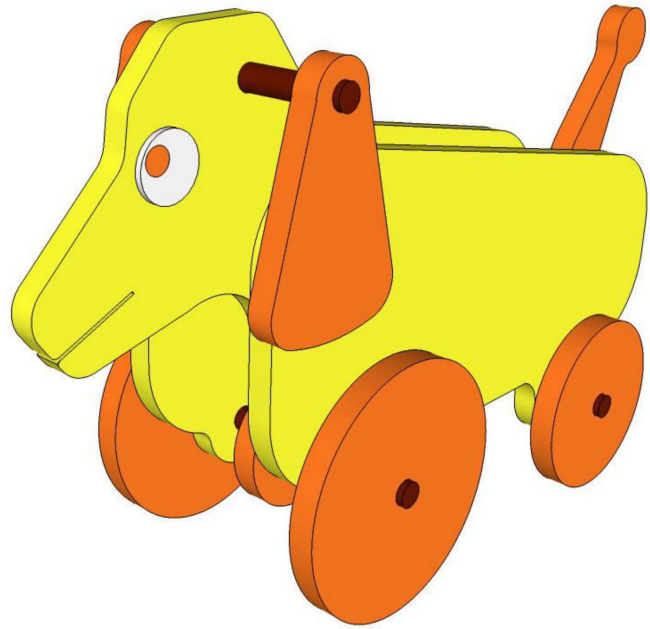

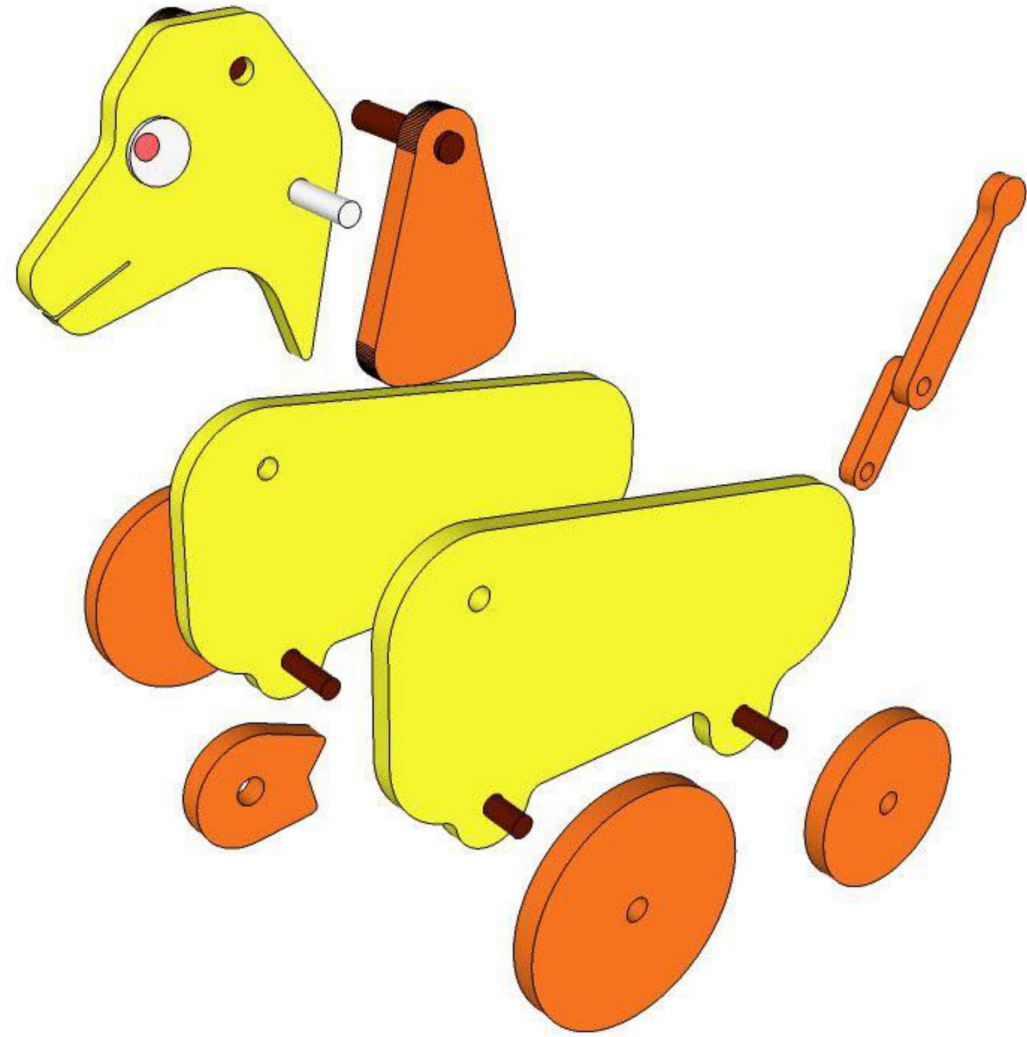

# PRODUCT DIMENSIONS:

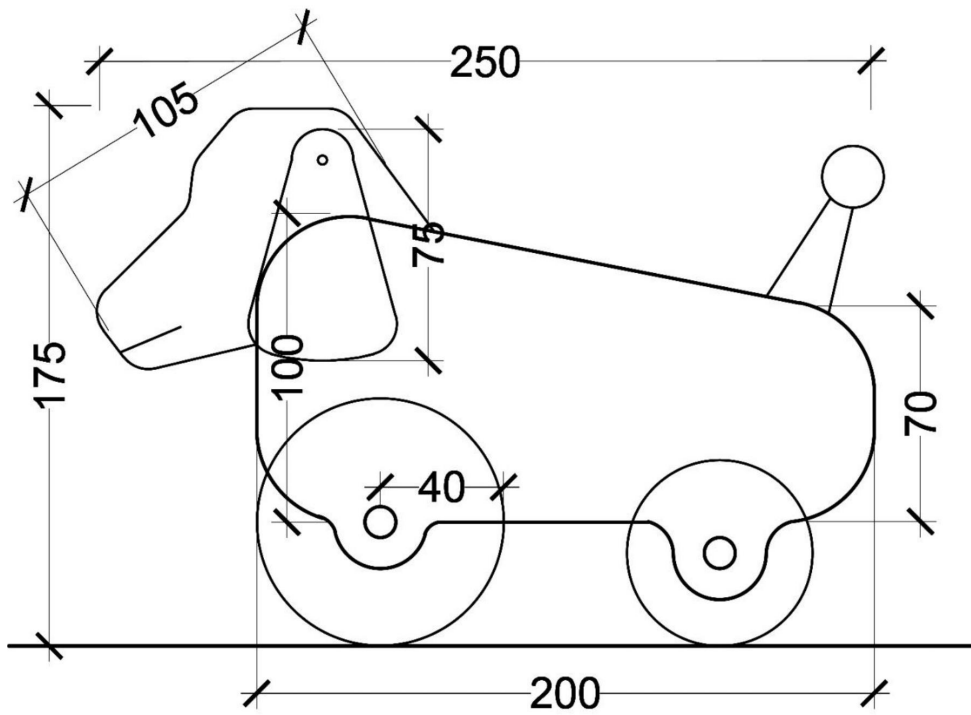

All dimensions are in millimeters

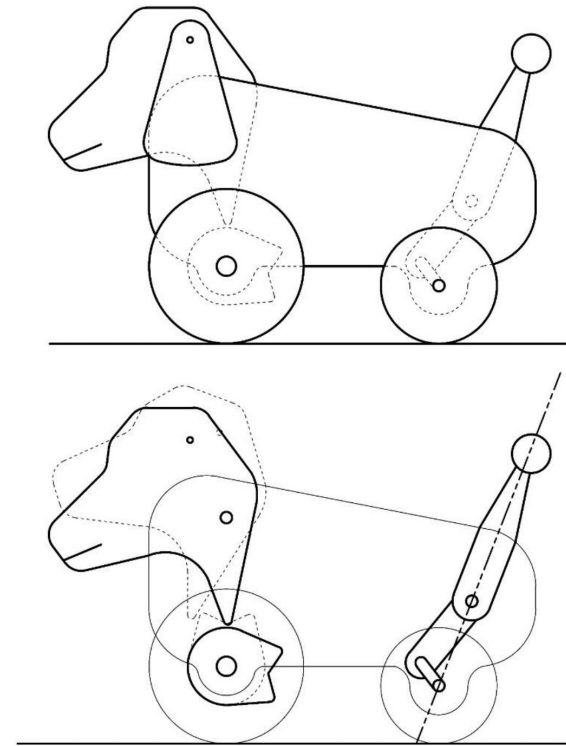

## FINAL MODEL:

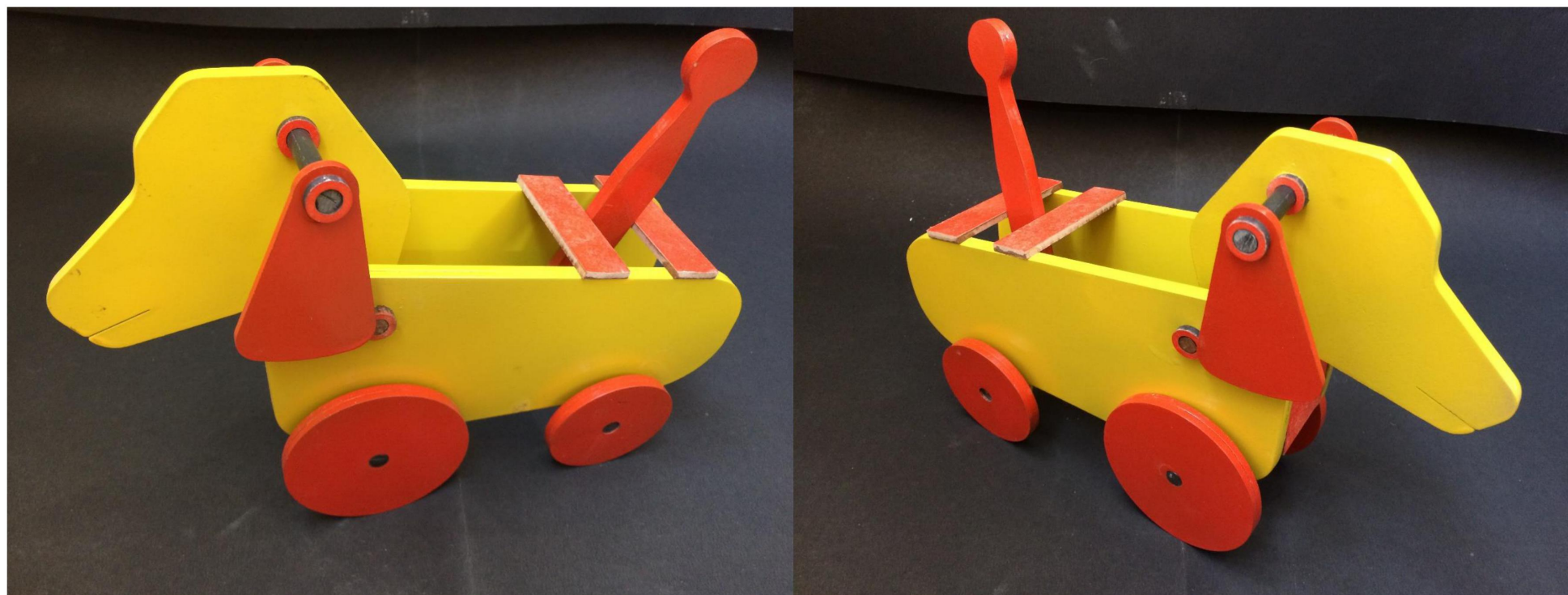

## **BRANDING:**

### Brand Narrative:

It is the ROXY® philosophy that 'good quality play' enriches a child's life and lays the foundation for later adult life. We believe that play is a key element in children's growth and development and stimulates the imagination and the emergence of ideas and creative expression. All ROXY products are based on this underlying philosophy of making your child's life a beautiful experience.



THANK YOU