

Design Resource

C3 Stand

A Multipurpose Stand

by

Prof. P. Kumaresan

IDC, IIT Bombay

Source:

<https://dsource.in/resource/c3-stand>

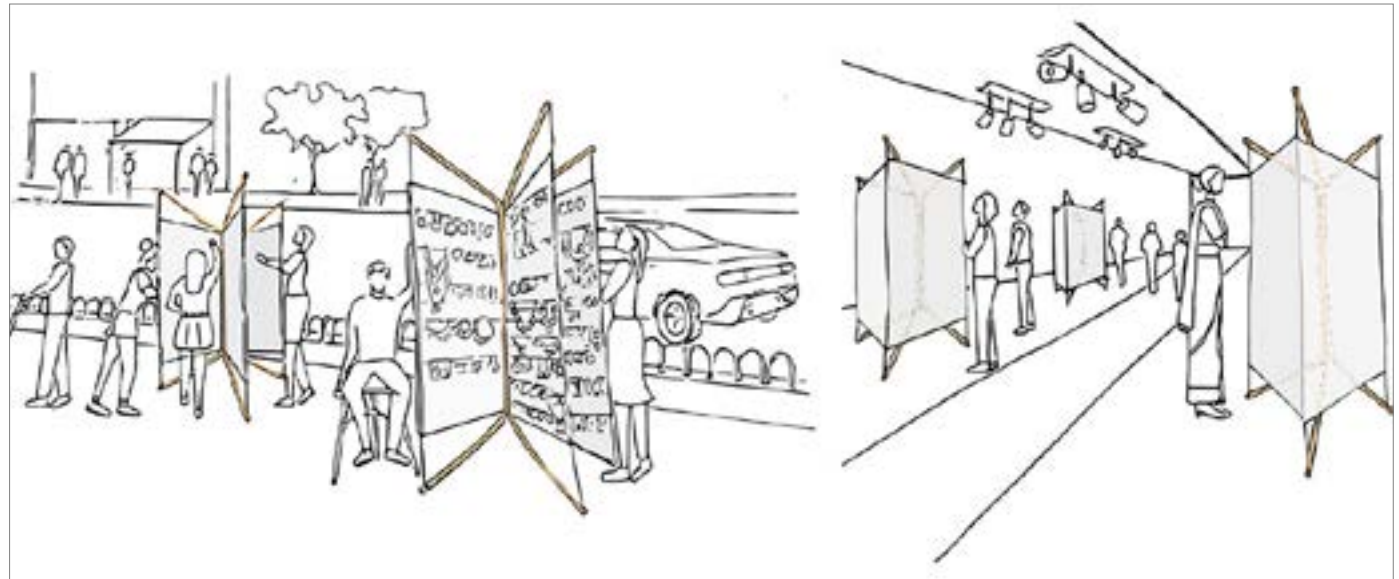

1. Introduction
2. Things You Need
3. Let's Make
4. Personal Touch
5. Links and References
6. Video
7. Contact Details

Design Resource

C3 Stand

A Multipurpose Stand
by
Prof. P. Kumaresan
IDC, IIT Bombay

Source:

<https://dsource.in/resource/c3-stand/introduction>

Introduction

C3 Stand is a versatile solution to lot of activities of everyday life. Initially conceived as an exhibition stand at IDC, this stand can serve in a lot many ways. With minimum materials, any novice maker can make this stand. The beauty of the stand is that it does not require any nut, bolts. It works on the simple concept of snap fit. Hence the stand can be easily assembled, dismantled and carried. Besides Exhibition space, it can be used in hostels, studio apartments, and outdoor display areas. If you are a homemaker, you can use this as a cloth hanger.

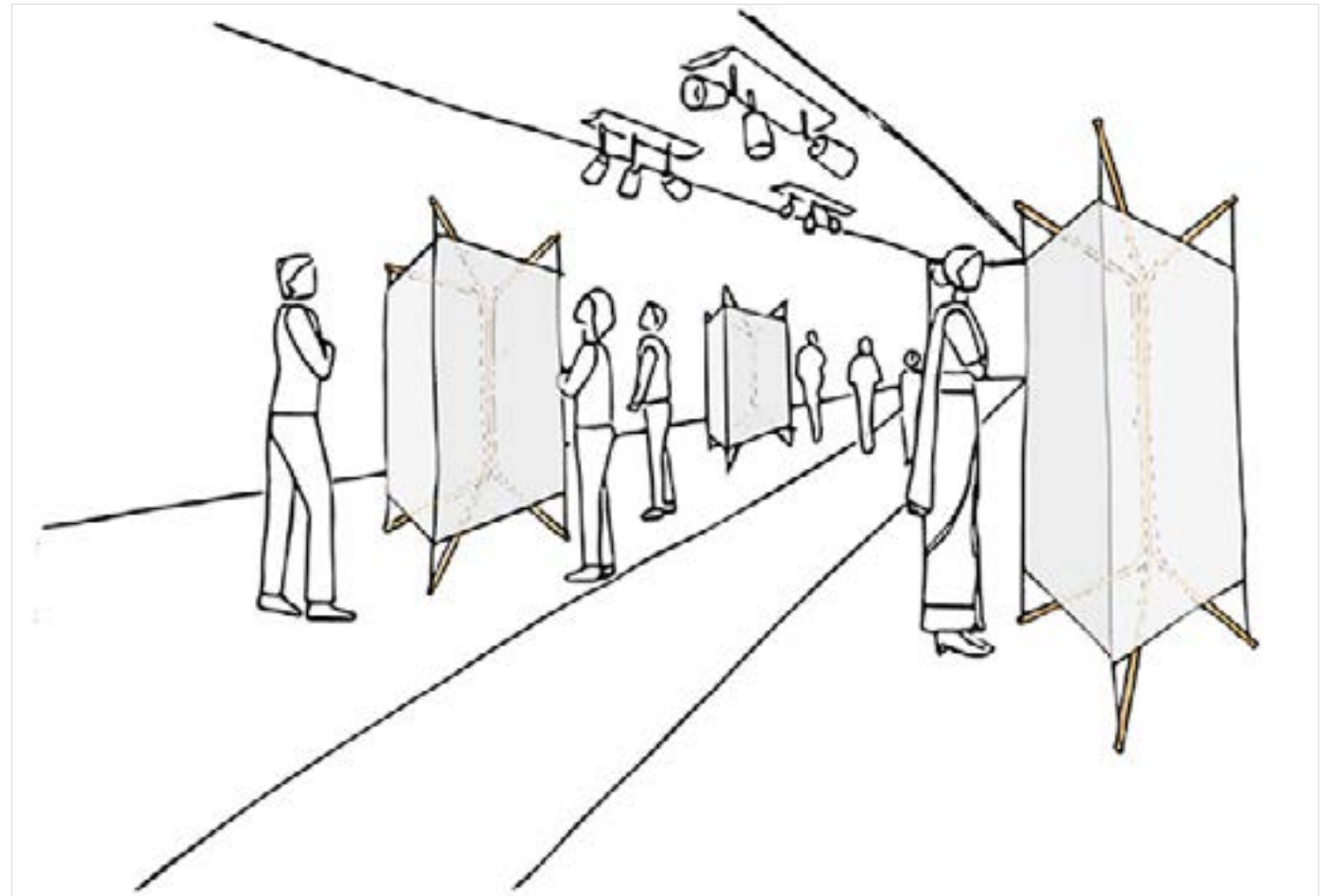

C3 stand when used as an exhibition stand. The panels can be hung from the stand at 3 points. The stand can accommodate three panels.

1. Introduction
2. Things You Need
3. Let's Make
4. Personal Touch
5. Links and References
6. Video
7. Contact Details

Design Resource

C3 Stand

A Multipurpose Stand

by

Prof. P. Kumaresan

IDC, IIT Bombay

Source:

<https://dsource.in/resource/c3-stand/introduction>

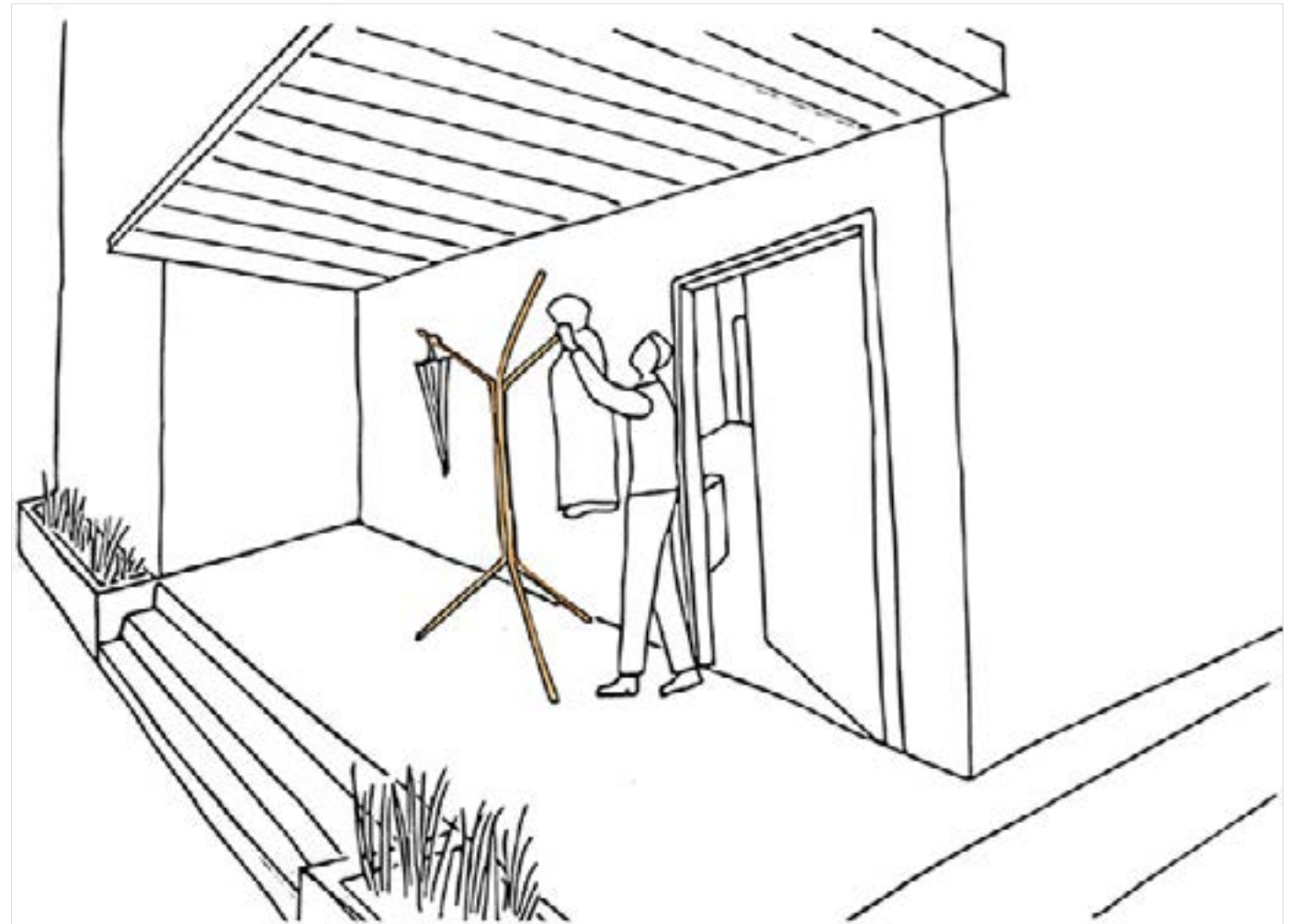

Monsoon in Mumbai? Hang your raincoat outside. You can also use it to hang a few shirts in your room.

1. Introduction

2. Things You Need

3. Let's Make

4. Personal Touch

5. Links and References

6. Video

7. Contact Details

Design Resource

C3 Stand

A Multipurpose Stand

by

Prof. P. Kumaresan

IDC, IIT Bombay

Source:

<https://dsource.in/resource/c3-stand/introduction>

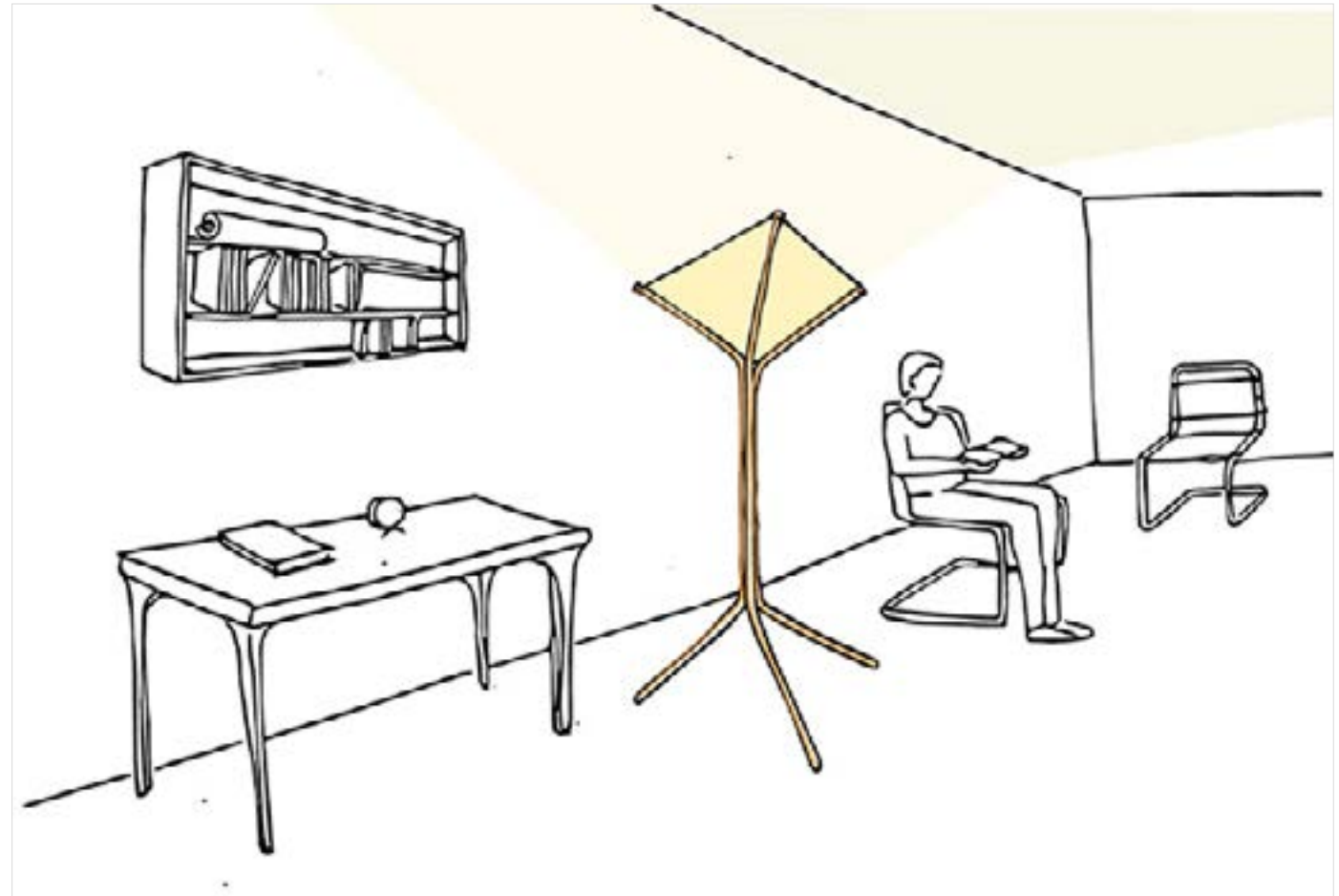

Want to make a funky lampshade? Use a cloth or paper to turn it to lampshade.

1. Introduction

2. Things You Need

3. Let's Make

4. Personal Touch

5. Links and References

6. Video

7. Contact Details

Design Resource

C3 Stand

A Multipurpose Stand

by

Prof. P. Kumaresan

IDC, IIT Bombay

Source:

<https://dsource.in/resource/c3-stand/introduction>



If you have retail shop, you can display some of your products on this stand.

1. Introduction
2. Things You Need
3. Let's Make
4. Personal Touch
5. Links and References
6. Video
7. Contact Details

Design Resource

C3 Stand

A Multipurpose Stand

by

Prof. P. Kumaresan

IDC, IIT Bombay

Source:

<https://dsource.in/resource/c3-stand/things-you-need>

Things You Need

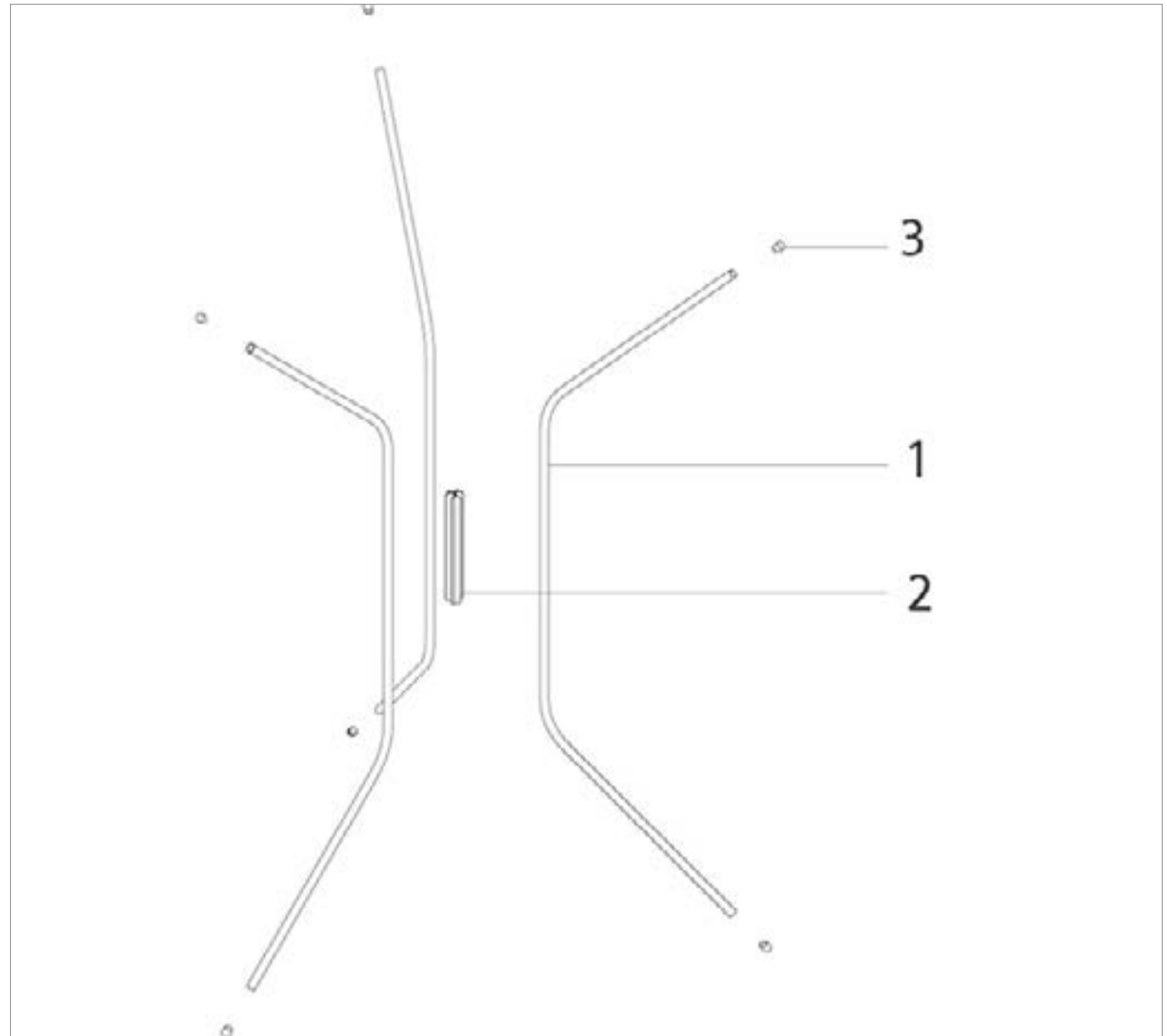

1. Introduction

2. Things You Need

3. Let's Make

4. Personal Touch

5. Links and References

6. Video

7. Contact Details

Design Resource

C3 Stand

A Multipurpose Stand

by

Prof. P. Kumaresan

IDC, IIT Bombay

Source:

<https://dsource.in/resource/c3-stand/things-you-need>

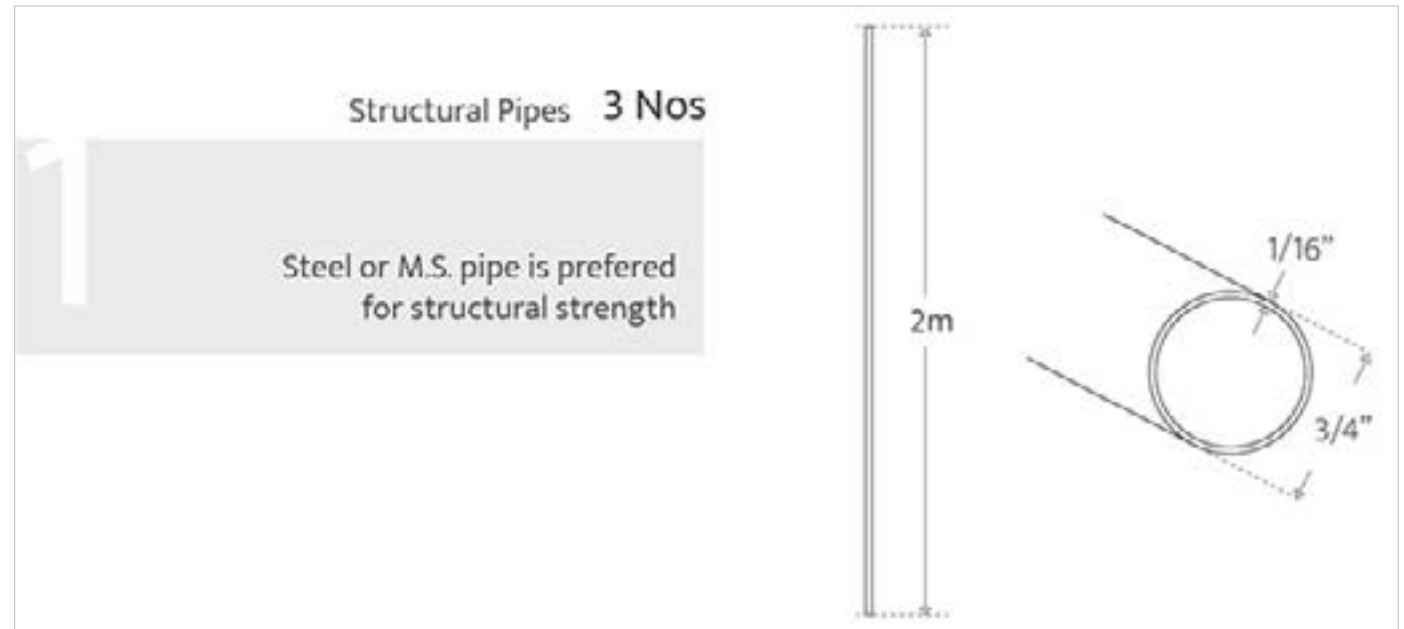

Commonly available metal pipes are of the following diameters: 1/2inch, 3/4 inch, 1 inch, 2 inch, 3 inch. For this stand, you can use 3/4-inch dia metal pipe.

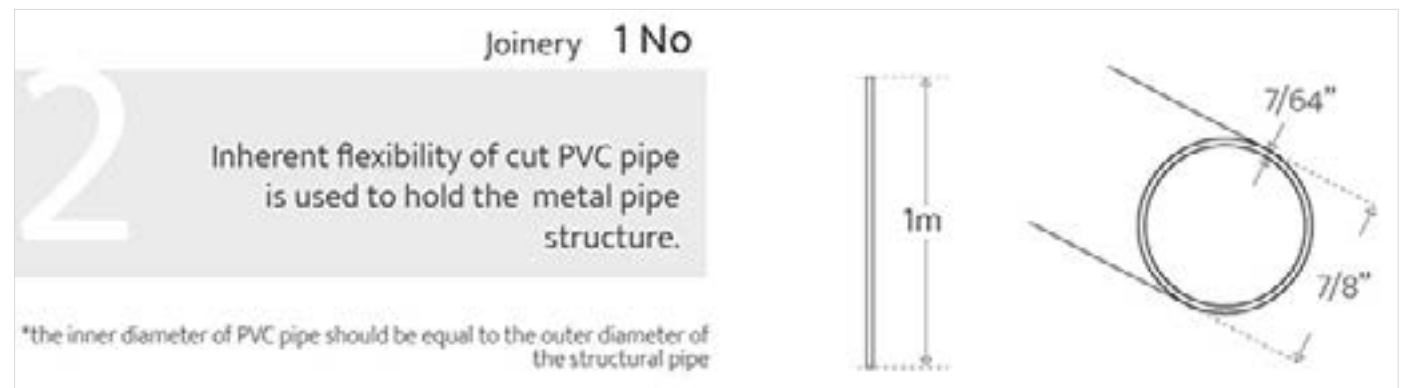

1/2" PVC pipe (7/8" inch outer diameter) should be ideally used to hold 3/4 inch metal pipe.

1. Introduction

2. Things You Need

3. Let's Make

4. Personal Touch

5. Links and References

6. Video

7. Contact Details

Design Resource

C3 Stand

A Multipurpose Stand

by

Prof. P. Kumaresan

IDC, IIT Bombay

Source:

<https://dsource.in/resource/c3-stand/things-you-need>

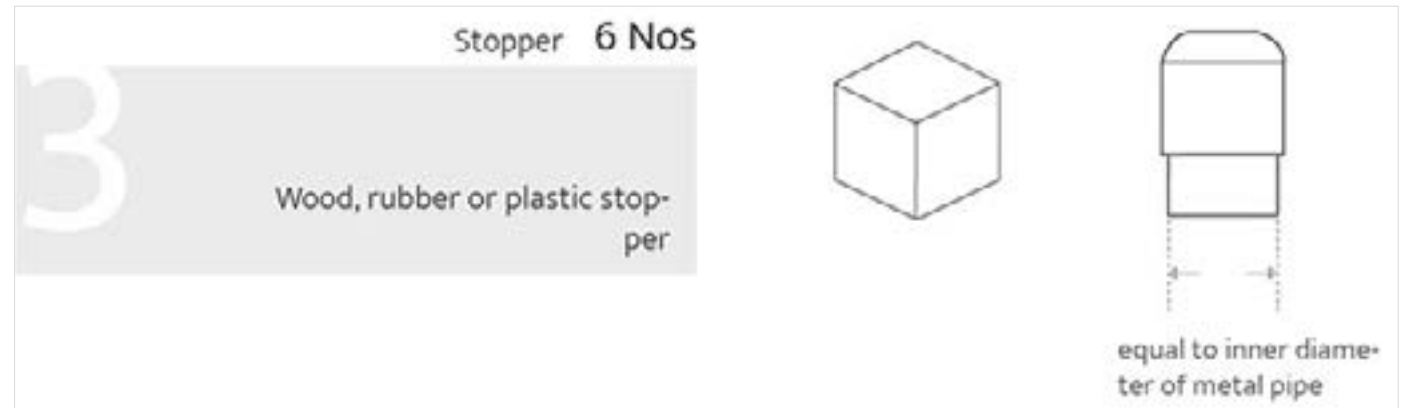

Wood or plastic solid pieces of 2x2x2 inch can be used to make the stopper.

Tools and Equipment:

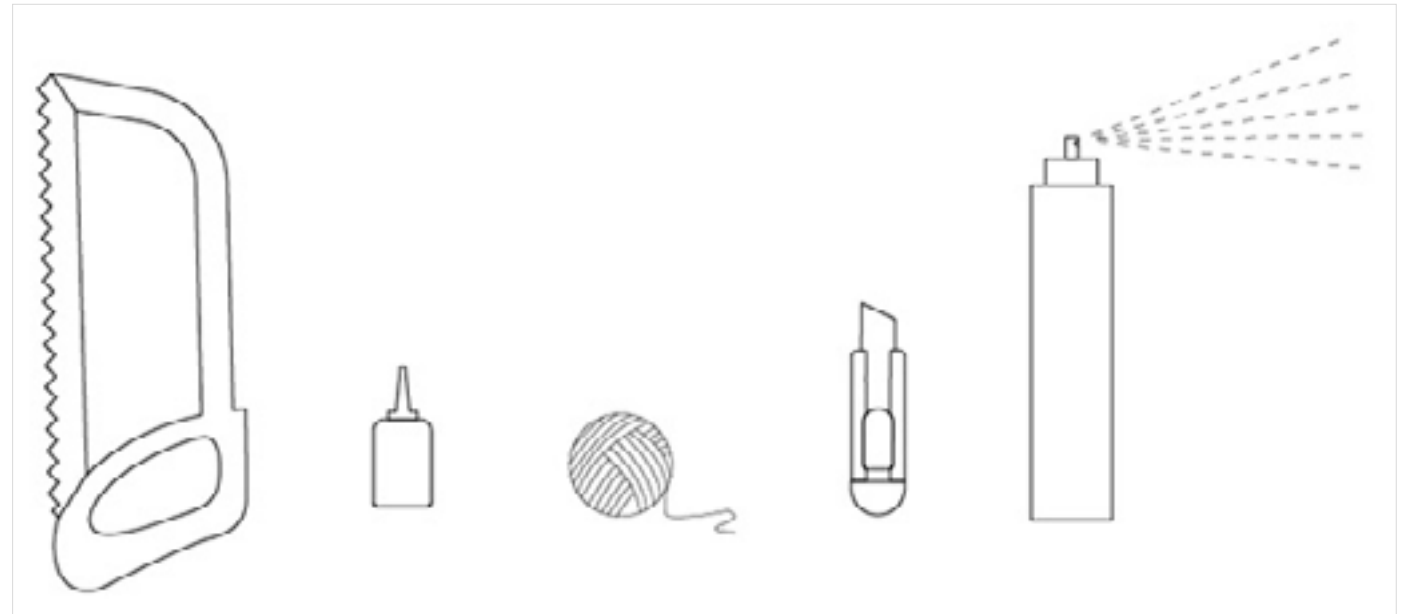

- **General Equipment:** Hacksaw, Adhesive (fevikwik), Thread, Cutter, Spray paint.
- **Advanced Equipment:** Pipe bending machine, Sanding machine, PVC pipe cutting machine.

1. Introduction

2. Things You Need

3. Let's Make

4. Personal Touch

5. Links and References

6. Video

7. Contact Details

Design Resource

C3 Stand

A Multipurpose Stand

by

Prof. P. Kumaresan

IDC, IIT Bombay

Source:

<https://dsource.in/resource/c3-stand/let%E2%80%99s-make>

1. Introduction
2. Things You Need
3. Let's Make
4. Personal Touch
5. Links and References
6. Video
7. Contact Details

Let's Make

Drawings Download.....

Step 1: Bend the structural pipe from both the ends.

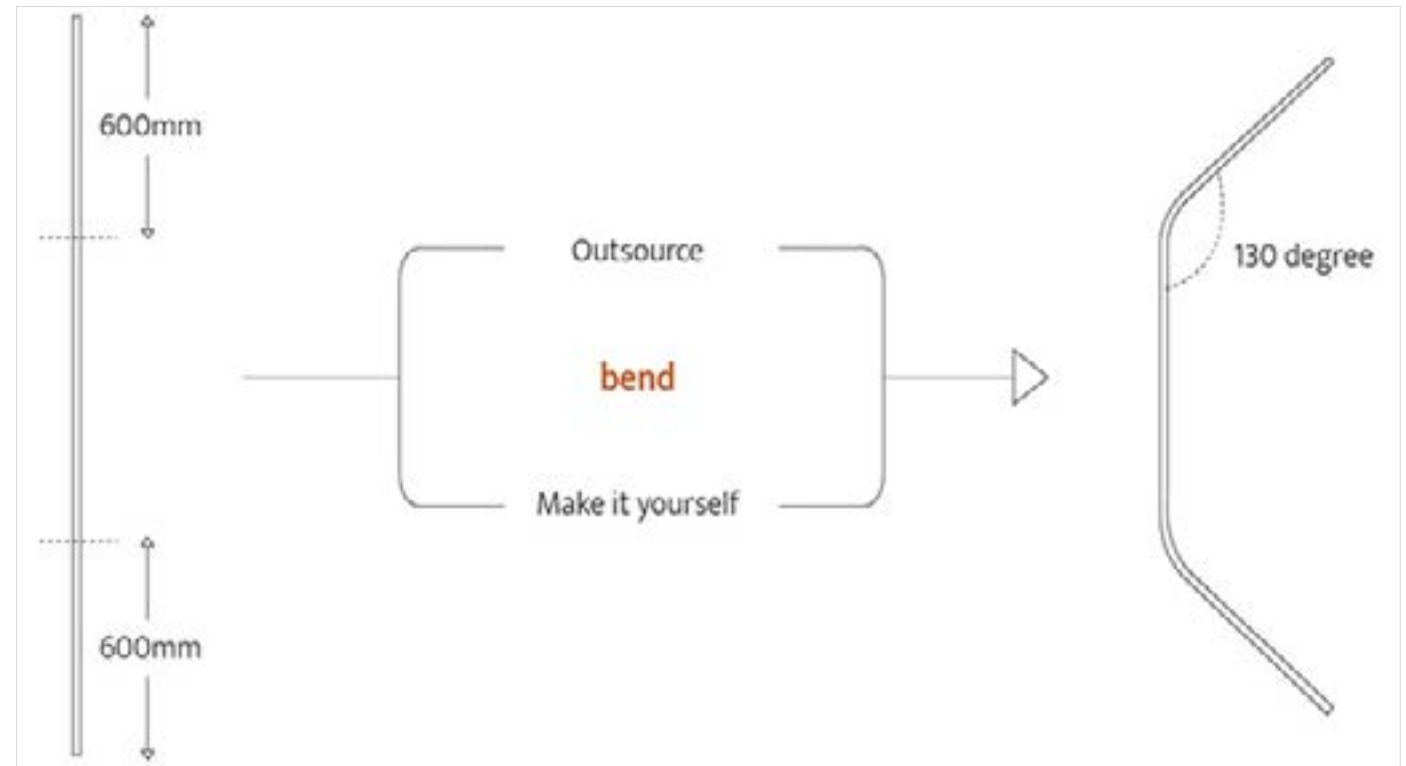

Outsource: Get it done by a local manufacturer.

Contacts of local pipe bending vendors.

Make it yourself: Use a pipe bending machine/tool.

Links to videos for pipe bending process.

Design Resource

C3 Stand

A Multipurpose Stand

by

Prof. P. Kumaresan

IDC, IIT Bombay

Source:

<https://dsource.in/resource/c3-stand/let%E2%80%99s-make>

Step 2: Cut the PVC pipe for the central joinery.

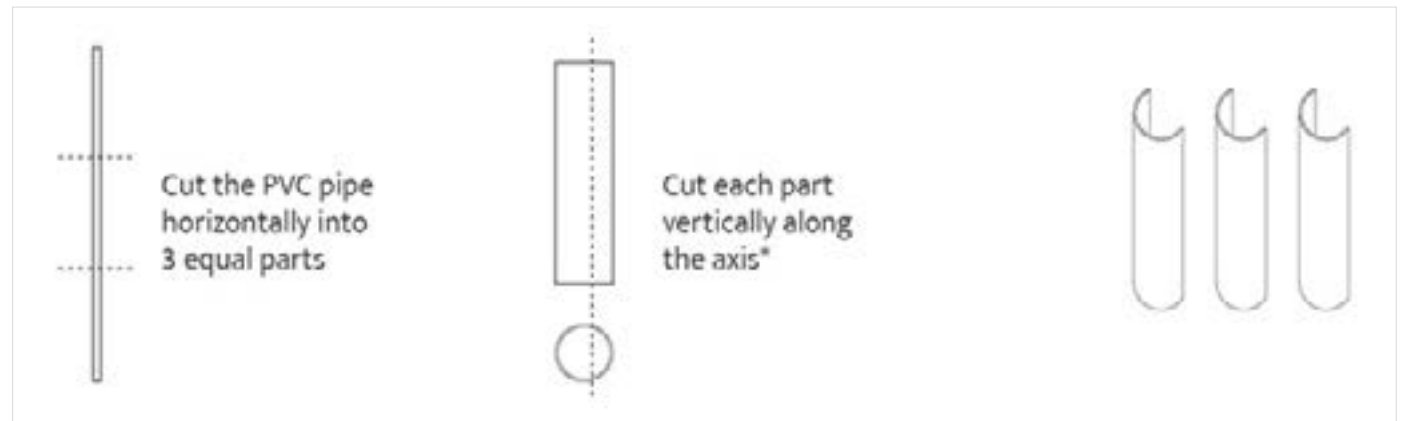

1. Introduction
2. Things You Need
3. Let's Make
4. Personal Touch
5. Links and References
6. Video
7. Contact Details

Design Resource

C3 Stand

A Multipurpose Stand

by

Prof. P. Kumaresan

IDC, IIT Bombay

Source:

<https://dsource.in/resource/c3-stand/let%E2%80%99s-make>

*The vertical cut should be more than half so that it snaps to the structural pipe.

Outsource: Get it done by a local manufacturer.

Make it yourself: Use a bench vise to hold the PVC pipe and cut with a hacksaw. Or you can use a sanding machine shown in the video.

Links to videos for PVC pipe cutting process.

Step 3: Stick the cut PVC pipes.

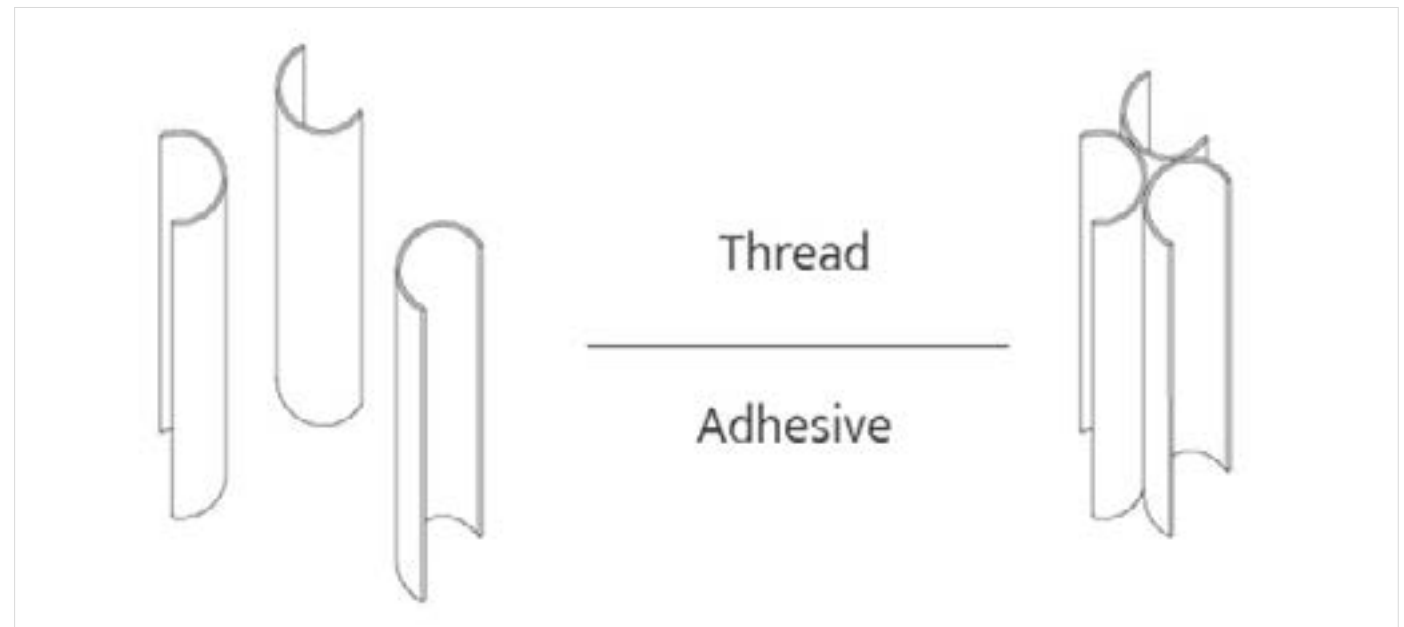

1. Introduction

2. Things You Need

3. Let's Make

4. Personal Touch

5. Links and References

6. Video

7. Contact Details

Design Resource

C3 Stand

A Multipurpose Stand

by

Prof. P. Kumaresan

IDC, IIT Bombay

Source:

<https://dsource.in/resource/c3-stand/let%E2%80%99s-make>

1. Introduction

2. Things You Need

3. Let's Make

4. Personal Touch

5. Links and References

6. Video

7. Contact Details



Place the three PVC pipes as shown above and place thread strands in between. Sip adhesive (Fevi Kwik) through the thread strands. Hold the pipes firmly till the adhesive dries.

Design Resource

C3 Stand

A Multipurpose Stand

by

Prof. P. Kumaresan

IDC, IIT Bombay

Source:

<https://dsource.in/resource/c3-stand/let%E2%80%99s-make>

Step 4: Make the wooden stopper in lathe machine.

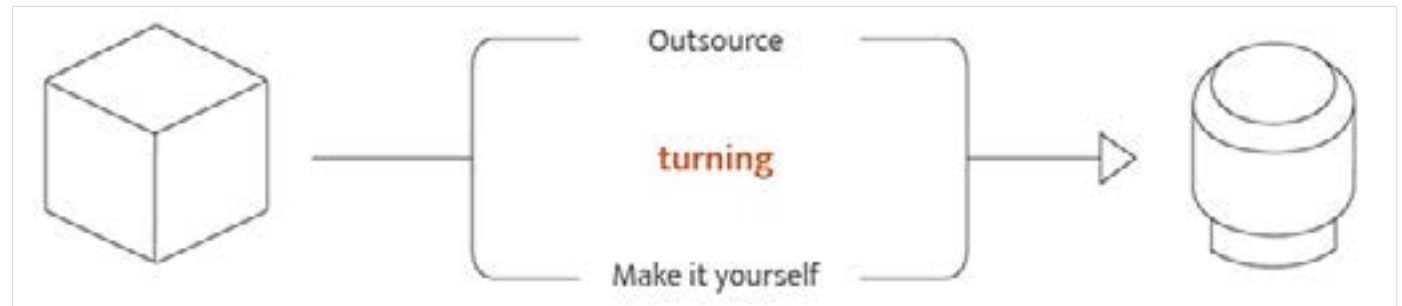

Outsource: Get it done by a local manufacturer.

Make it yourself: Make it using hand tools like saw, chisel and sanding equipments.

Contacts of vendors for lathe machine.

Links to videos for lathe turning.

Step 5: Paint all the components.

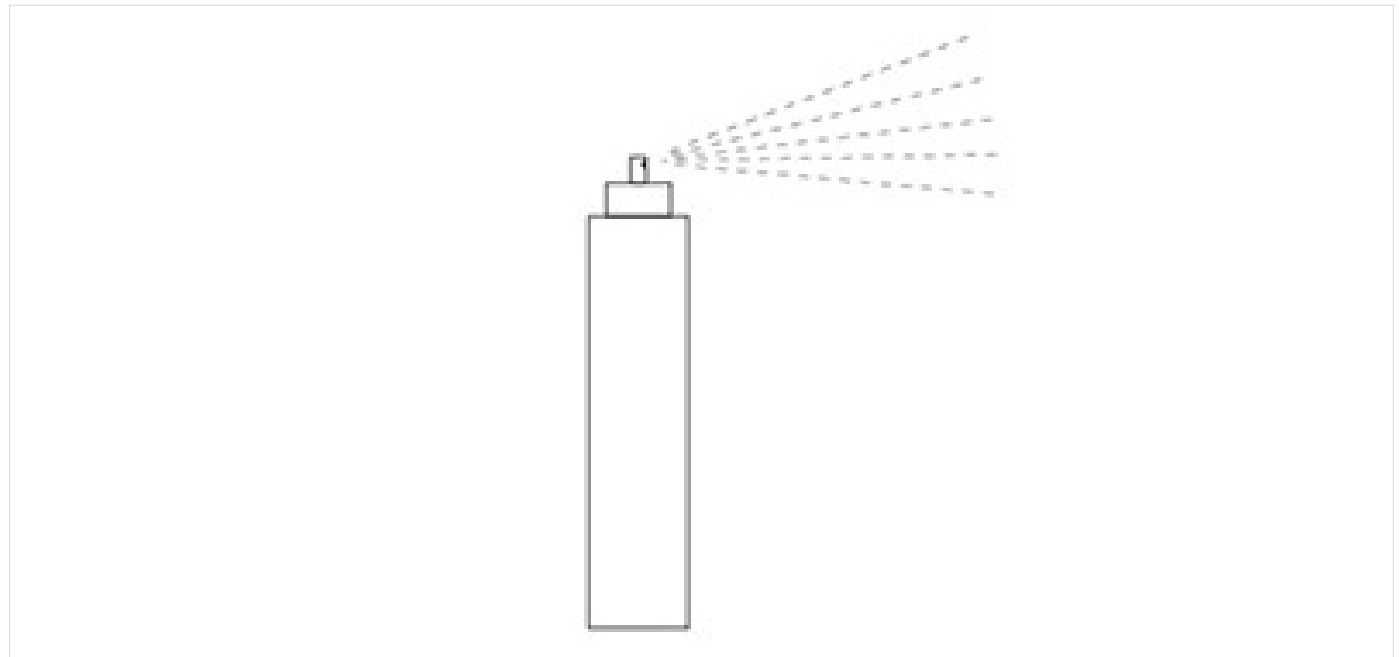

1. Introduction

2. Things You Need

3. Let's Make

4. Personal Touch

5. Links and References

6. Video

7. Contact Details

Design Resource

C3 Stand

A Multipurpose Stand

by

Prof. P. Kumaresan

IDC, IIT Bombay

Source:

<https://dsource.in/resource/c3-stand/let%E2%80%99s-make>

Step 6: Assemble it in just 2 mins!



1. Introduction
2. Things You Need
3. Let's Make
4. Personal Touch
5. Links and References
6. Video
7. Contact Details

Design Resource

C3 Stand

A Multipurpose Stand

by

Prof. P. Kumaresan

IDC, IIT Bombay

Source:

<https://dsource.in/resource/c3-stand/personal-touch>

Personal Touch

C3 Stand is a multifunctional unit, which can be personalised according the following functions.



Exhibition Stand

1. Introduction
2. Things You Need
3. Let's Make
4. Personal Touch
5. Links and References
6. Video
7. Contact Details

Design Resource

C3 Stand

A Multipurpose Stand

by

Prof. P. Kumaresan

IDC, IIT Bombay

Source:

<https://dsource.in/resource/c3-stand/personal-touch>

1. Introduction
2. Things You Need
3. Let's Make
4. Personal Touch
5. Links and References
6. Video
7. Contact Details



Clothe Stand

Design Resource

C3 Stand

A Multipurpose Stand

by

Prof. P. Kumaresan

IDC, IIT Bombay

Source:

<https://dsource.in/resource/c3-stand/personal-touch>

1. Introduction
2. Things You Need
3. Let's Make
4. Personal Touch
5. Links and References
6. Video
7. Contact Details



Lamp Shade

Design Resource

C3 Stand

A Multipurpose Stand

by

Prof. P. Kumaresan

IDC, IIT Bombay

Source:

<https://dsource.in/resource/c3-stand/links-and-references>

Links and References

Videos

Pipe Bending Videos:

- <https://www.youtube.com/watch?v=9ErSCmabAFg>
- <https://www.youtube.com/watch?v=-5a3oTSdP3U>
- <https://www.youtube.com/watch?v=ATrDYYPsXaw>
- https://www.youtube.com/watch?v=3n_lf2RHIPs
- <https://www.youtube.com/watch?v=4z2NFwftLKw>
- <https://www.youtube.com/watch?v=QjybH5jJqTY>
- https://www.youtube.com/watch?v=3n_lf2RHIPs

PVC Pipe Cutting Videos:

- <https://www.youtube.com/watch?v=P86igHWR6Eo>

Lathe Turning Videos:

- https://www.youtube.com/watch?v=2_P19jZjGOk
- <https://www.youtube.com/watch?v=f8v-59KFMhg>
- https://www.youtube.com/watch?v=_2ztQKZbCIY
- <https://www.youtube.com/watch?v=S8KrtPQfXQ0>
- <https://www.youtube.com/watch?v=jOvF5f1phhY>

1. Introduction

2. Things You Need

3. Let's Make

4. Personal Touch

5. Links and References

6. Video

7. Contact Details

Design Resource

C3 Stand

A Multipurpose Stand

by

Prof. P. Kumaresan

IDC, IIT Bombay

Source:

<https://dsource.in/resource/c3-stand/video>

Video



C3 Stand Making Part1



C3 Stand Making Part2



C3 Stand Making Part3

1. Introduction
2. Things You Need
3. Let's Make
4. Personal Touch
5. Links and References
6. Video
7. Contact Details

Design Resource

C3 Stand

A Multipurpose Stand

by

Prof. P. Kumaresan

IDC, IIT Bombay

Source:

<https://dsource.in/resource/c3-stand/contact-details>

Contact Details

This documentation was done by Prof. Kumaresan and team at [IDC, IIT Bombay](#).

You can get in touch with him at [kums\[at\]iitb.ac.in](mailto:kums[at]iitb.ac.in)

You can write to the following address regarding suggestions and clarifications:

Suggested Vendors in Mumbai (For Pipe Bending)

KRYSTAL ENTERPRISES

B- 1 Jorem Chayya Market,

P.V.K. Compound, Laxminarayan Mandir Marg,

Kherani Road, Mumbai - 400072

India

Email: [krystalenterprises\[at\]hotmail.com](mailto:krystalenterprises[at]hotmail.com)

Helpdesk Details:

Co-ordinator

Project e-kalpa

Industrial Design Centre

IIT Bombay

Powai

Mumbai 4000 076

India

Phone: 091-22-25767820/ 7801/ 7802

Fax: 091-22-25767803

Email: [dsource.in\[at\]gmail.com](mailto:dsource.in[at]gmail.com)

1. Introduction

2. Things You Need

3. Let's Make

4. Personal Touch

5. Links and References

6. Video

7. Contact Details